

Phaseline Series High Performance Phase Stable Test Cable

PL40/2.92mm Male /2.92mm Female/DC-40 GHz

Model: PL40-2.92M2.92F-L

Features:

- Max Frequency 40 GHz
- VSWR max of 1.30
- Velocity of Propagation of 76%



Applications:

- Test & Measurement equipment
- Manufacturing lab
- WAN system equipment

Cable Cross Section:

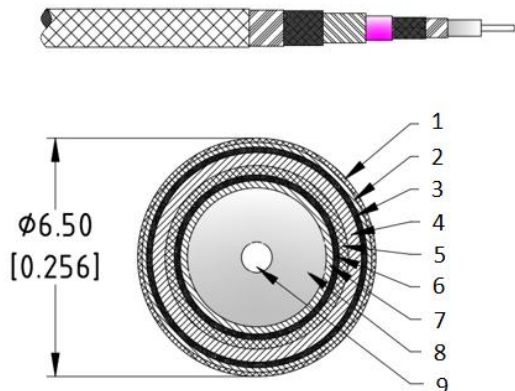

- 1—编织护套 PTFE Braiding Jacket
- 2—外扎带 Outer tie
- 3—耐扭转编织层 Torsion-resistant braid
- 4—抗压保护层 Compression protective layer
- 5—电缆护套 Cable Jacket
- 6—外屏蔽层 Outer Shield
- 7—内屏蔽层 Inner Shield
- 8—绝缘介质 Insulator PTFE
- 9—芯线 Inner conductor

Electrical Characteristics:

Parameter	Min	Typ	Max	Units
Frequency Range	DC		40	GHz
VSWR		1.20	1.30	:1
Velocity of propagation		76%		
Shielding Effectiveness	90			dB
Capacitance			87	pF/m
Phase Stability Vs. Flexure@40GHz		±4		°
Amplitude Stability Vs. Flexure@40GHz		±0.03		dB

Environmental And Physical Characteristics:

Description	Parameter	Units
Cable Diameter	6.5	mm
Cable Jacket	PTFE	
Min. Bending Radius	65	mm
Typical Flex life	50000	
Operating Temperature	-55 to +150	°C
Storage Temperature	-55 to +165	°C

Cable Performance By Frequency

Frequency	2 GHz	4 GHz	6 GHz	8 GHz	12 GHz	16 GHz	18 GHz	26.5 GHz	40GHz
Insertion Loss (dB/m Max)	0.62	0.88	1.09	1.26	1.35	1.80	1.92	2.35	2.92
RF Power CW (W Max.)	230	162	132	114	110	79	75	61	49

Connectors:

Description	Connector 1	Connector 2
Type	2.92mm Straight Male	2.92mm Straight Female
Contact Material And Plating	Beryllium Copper,Gold	Beryllium Copper,Gold
Dielectric Type	PEI	PEI
Body Material And Plating	Passivated Stainless Steel	Passivated Stainless Steel
Insertion Loss (dB Max)	$0.05 * \sqrt{f_{GHz}}$	$0.05 * \sqrt{f_{GHz}}$

Outline Drawing:

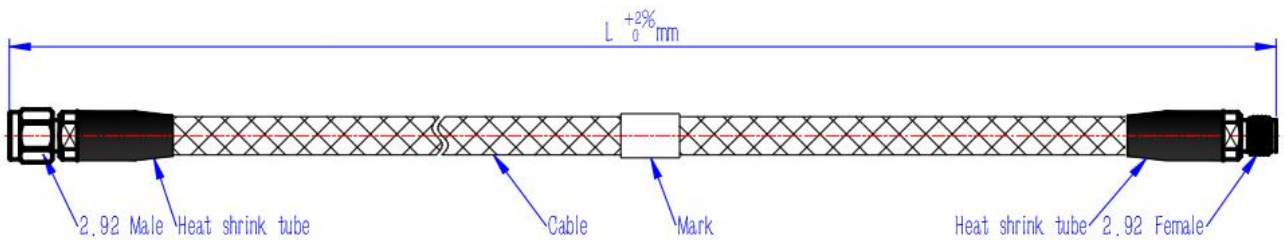

Ordering Information:

Base Number	Lenth	Armour	Phase/delay Matched (optional)
PL40-2.92M2.92F	-L	Purple black braided armor	-XXPS($\leq \pm XX$ PS) -XX°($\pm XX^\circ$)

Typical Performance Data:

Model:PL40-2.92M2.92F-1m

Frequency	2 GHz		6 GHz		12 GHz		18 GHz		26.5 GHz		40GHz	
	Typ	Max	Typ	Max	Typ	Max	Typ	Max	Typ	Max	Typ	Max
Insertion Loss (dB)	0.69	0.76	1.21	1.33	1.73	1.90	2.13	2.24	2.61	2.86	3.23	3.55
VSWR	1.02	1.10	1.03	1.10	1.05	1.2	1.10	1.2	1.10	1.30	1.15	1.30

