

**Model: TLLA4G8G-25-11**
**Low Noise Amplifier**
**4-8GHz, NF:1.1dB, Gain:25dB, P1dB:16dBm**
**Feature:**

- Ultra Wide Band: 4-8GHz
- Gain: 25dB Min
- Noise Figure: 1.1dB Typ.
- Good Power and Gain Flatness
- 50 Ohm Matched Input / Output

**电气特性 Electrical Specifications:**

参数 Parameter	Min	Typ	Max	单位 Units
频率范围 Frequency range	4-8			GHz
增益 Gain	25			dB
增益平坦度 Gain Flatness		±1.0		dB
噪声系数 Noise Figure		1.1		dB
线性输出功率 Output P1dB	14	16		dBm
输入驻波 Input VSWR		2.0	2.2	:1
输出驻波 Output VSWR		2.0	2.2	:1
直流电压 DC Voltage		+12		V DC
直流电流 DC Supply Current		80		mA
阻抗 Impedance	50			Ohms

**机械特性 Mechanical Specifications:**

参数 Parameter	指标 Value	单位 Units
输入/输出接口 Input /Output Connector	SMA Female/SMA Female	
直流偏置 DC Bias	Solder Pin	
尺寸 Size	32.1*29.2*11	mm

**绝对最大值 Absolute Maximum Ratings:**

参数 Parameter	指标 Value
供电偏置电压 Supply Bias Voltage	+15V
输入功率 RF Input Power	15 dBm
ESD灵敏度 ESD sensitivity (HBm)	Class 0, passed 150V

**Available 220V System  
Benchtop Amplifier**

外形尺寸 Outline Drawing:

Unit: mm

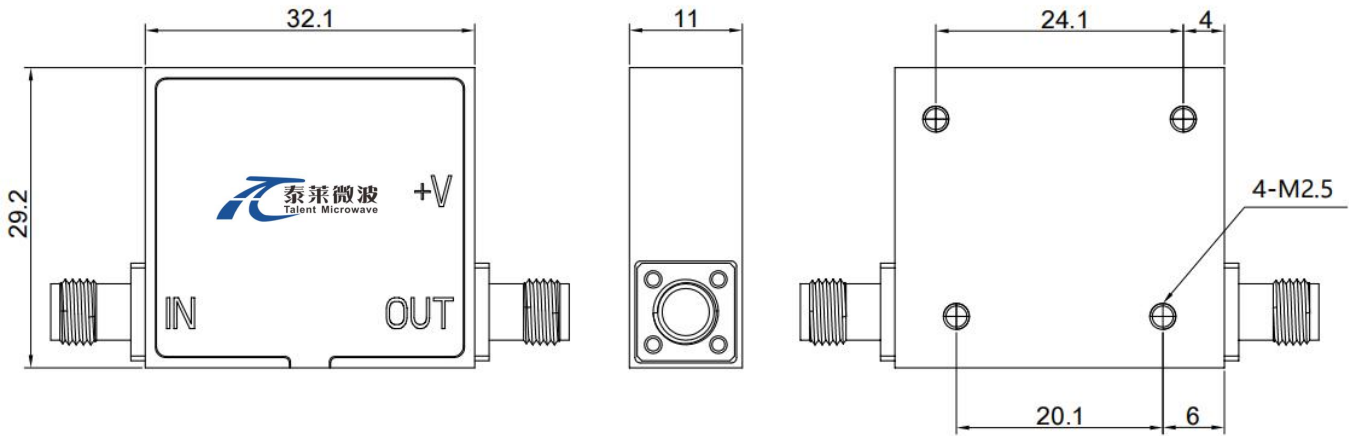

**\*\*\*Heat Sink Required During Operation**



OBSERVE PRECAUTIONS  
ELECTROSTATIC SENSITIVE  
DEVICES

温度环境 Environmental Conditions:

参数 Parameter	Min	Typ	Max	单位 Units
操作温度 Operating Temperature	-45		+85	°C
存储温度 Non-operating Temperature	-55		+125	°C
相对湿度 Relative humidity		95		%
海拔 Altitude	10,000			feet
震动 Shock / Vibration(MIL-STD-810F)	25g rms (15 degree 2KHz) endurance, 1 hour per axis			
冲击 Shock(non operating)	20G for 11msc half sin wave,3 axis both directions			

订货信息 Ordering Information:

标准型号 Part Number	描述 Description	版本号 Revision
TLLA4G8G-25-11	Low Noise Amplifier, 4-8GHz, Noise Figure:1.1dB, Gain:25 dB,P1dB:16dBm,+12V DC,Without Heatsink	Rev.1.2
TLLA4G8G-25-11-HS	Low Noise Amplifier, 4-8GHz, Noise Figure:1.1dB, Gain:25 dB,P1dB:16dBm,+12V DC,With Heatsink	Rev.1.2

典型曲线 Typical Performance Data:

Gain&VSWR vs Frequency

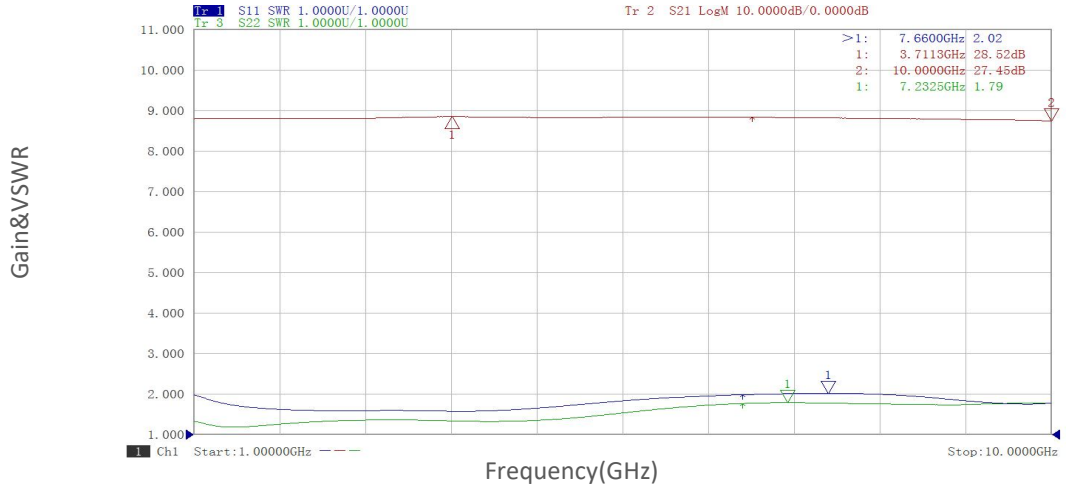

Noise Figure vs Frequency

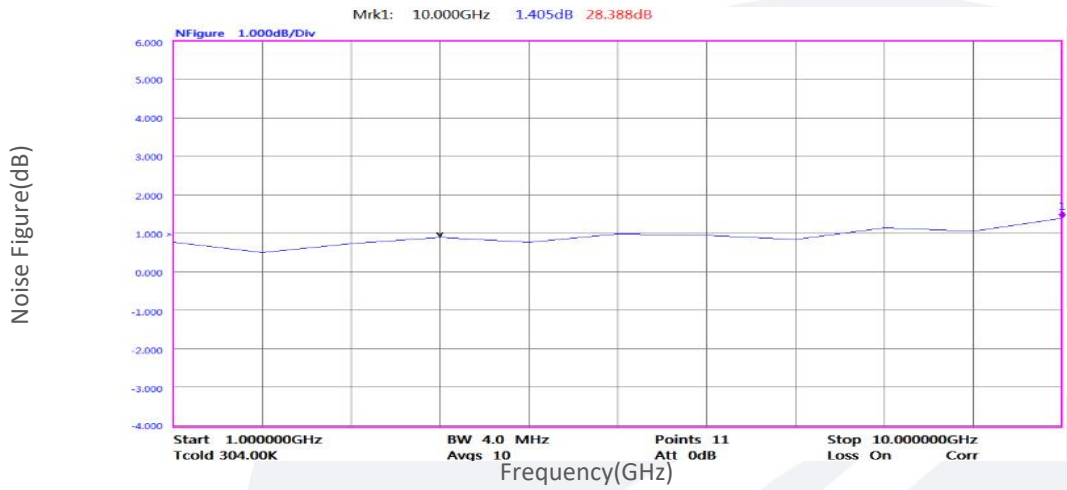

Gain vs Output Power

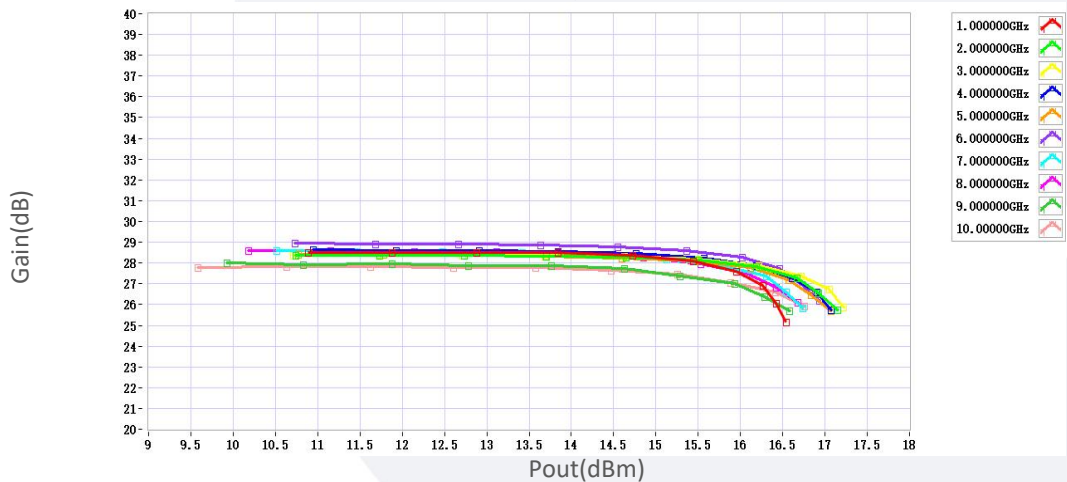

Note: Above data is for ref only, actual data may vary from unit to unit depending on operating environment and other factors like material lots etc.

典型曲线 Typical Performance Data:

P1dB vs Frequency

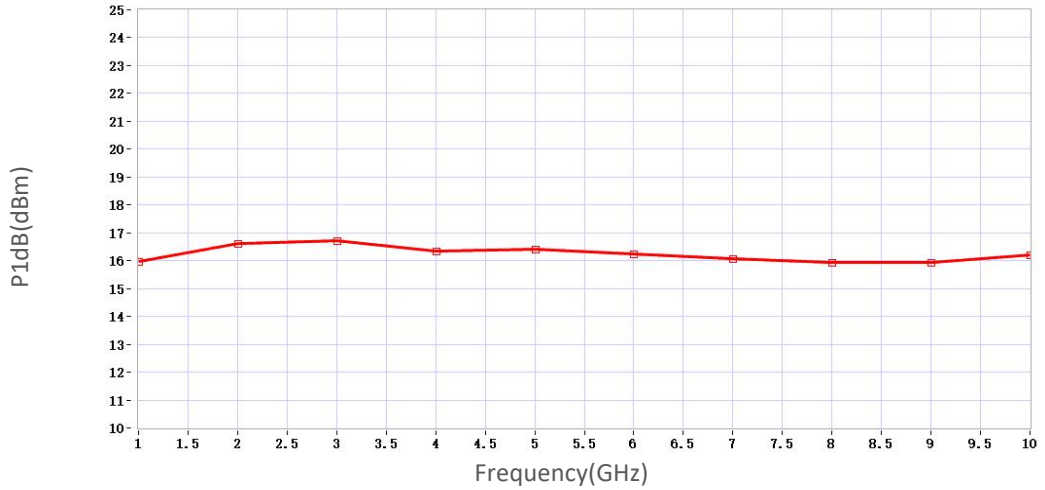

2nd Harmonic vs Output Power

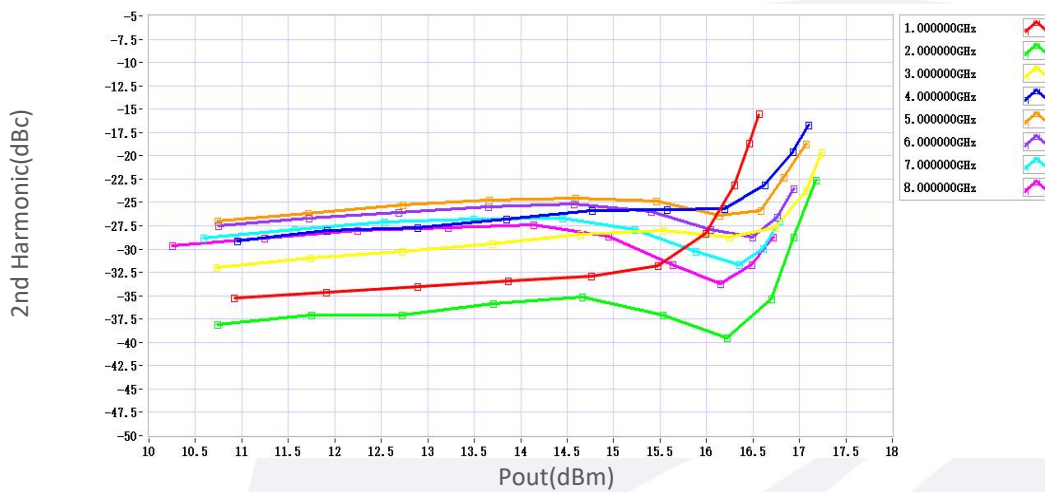

3rd Harmonic vs Output Power

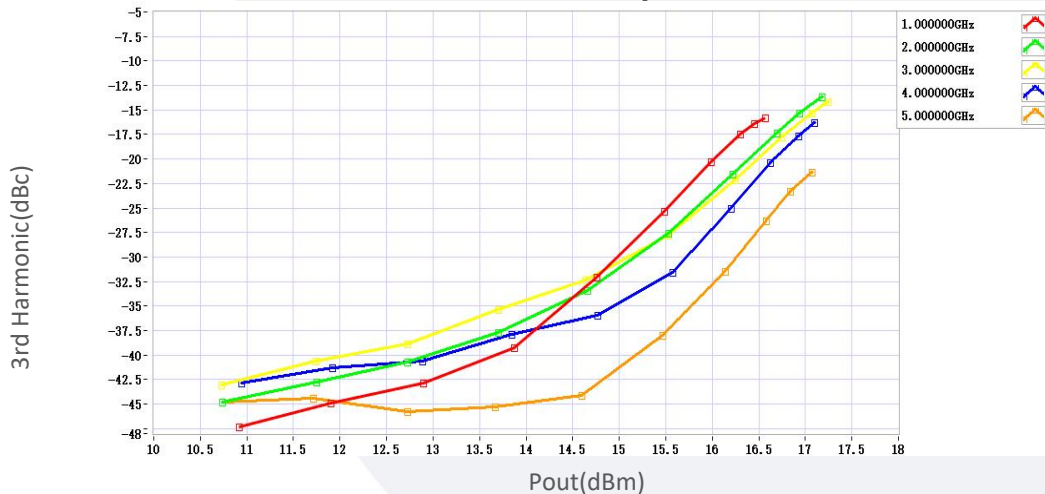

Note: Above data is for ref only, actual data may vary from unit to unit depending on operating environment and other factors like material lots etc.