

Flat needle direction①

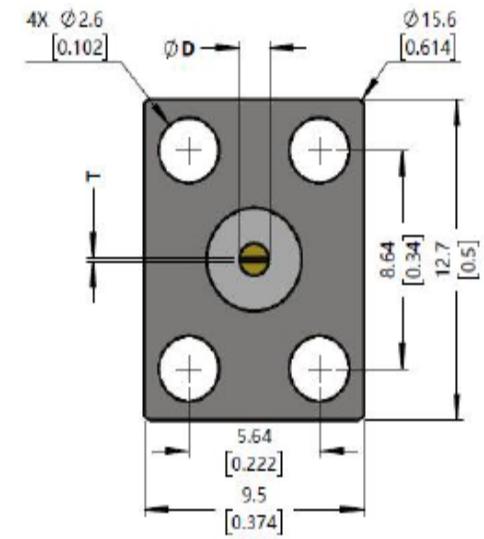

Flat needle direction②

Electrical & Environmental Characteristics	
Impedance	50 Ω
Insulation Resistance	5000 MΩ
Operating Frequency	DC~26.5GHz
Dielectric Withstanding Voltage	1000V
VSWR	≤1.15
Insertion Loss	≤0.05* $\sqrt{f\_GHz}$
Operating Temperature	- 55~+165℃
Material & Coat-Plating	
Inner Conductor	Beryllium Copper, Gold
Dielectric	PTFE
Body	Stainless Steel, Passivated
Coupling Nut	N/A

No.	Model	D(Diameter)	L(Length)	T(Thickness)	
1	SMA-KFD40314	1.27 [0.050]	1.27 [0.050]	0.15 [0.006]	①
2	SMA-KFD403C14	1.27 [0.025]	1.27 [0.050]	0.15 [0.006]	②
3	SMA-KFD40314-098	1.27 [0.025]	2.50 [0.098]	0.13 [0.005]	①
4	SMA-KFD403C14-098	1.27 [0.025]	2.50 [0.098]	0.13 [0.005]	②

THIS DRAWING IS A CONTROLLED DOCUMENT		DWN	Suzhou Talent Microwave, Inc		
		CHK			
Unit mm	TOLERANCES UNLESS OTHERWISE SPECIFIED 0 PLC ±0.25 1 PLC ±0.15 2 PLC ±0.12 3 PLC ± 3 PLC ± ANGLES ±1°	APVD	Product Model  SMA-KFD403C14 SMA Female Flange Connector		
MATERIAL SEE TABLE	FINISH SEE TABLE	WEIGHT	SIZE A4	GAGE CODE 0T8L4	DRAWING NO
		CUSTOMER DRAWING			SHEET1 OF 1
					RVE 1