

型号 Part No : TT2-67-1.85

DC-67GHz,2W,1.85mm Male Coaxial Fixed Terminations

电气特性 Electrical Specifications:

工作频率 Frequency Range: DC-67GHz
驻波 VSWR: ≤ 1.3
耐功率 RF Power Handling: ≤ 2 Watts
阻抗 Impedance: 50 Ohms



机械特性 Mechanical Specifications:

操作温度 Operation Temperature: $-55^{\circ}\text{C} - +125^{\circ}\text{C}$
存储温度 Storage Temperature: $-55^{\circ}\text{C} - +125^{\circ}\text{C}$
壳体 Body Material: Stainless Steel 303
中心导体 Center Conductor: Becu, Golden
接口 Connectors: 1.85mm Male
相对湿度 Relative Humidity: $\leq 90\%$

外形尺寸 Outline Drawing:

Unit: mm

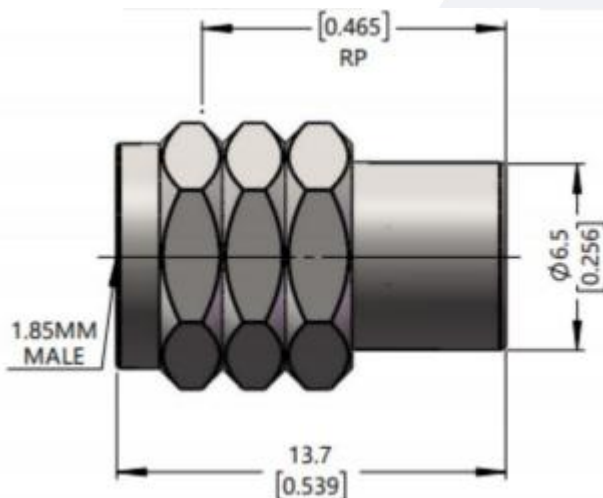

订货信息 Ordering Information:

标准型号 Part Number	描述 Description
TT2-67-1.85	DC-67GHz,2W,1.85mm Male Coaxial Fixed Termination

典型曲线 Typical Performance Data:

Input VSWR vs Frequency

