

Model: TLSM-050075-06-15
**V-band Spectrum Frequency Extension Systems
 50-75 GHz,WR-15**
Feature:

- Ultra Wide Band: 50-75 GHz
- Low conversion loss
- Unconditional stability
- High performance alternative to harmonic mixers

电气特性 Electrical Specifications :

参数Parameter	Min.	Typ.	Max.	单位Units
频率范围 Frequency range	50		75	GHz
中频输出频率 IF Output Frequency	DC		5	GHz
本振输入频率 LO Input Frequency	8.33		12.5	GHz
本振倍频次数 LO Multiplication Factor		6		
变频损耗 Mixer Conversion Loss SSB		8		dB
本振输入功率 LO Input Power	3	7	10	dBm
射频输入功率 RF Input Power		-10	0	dBm

机械特性 Mechanical Specifications :

参数Parameter	指标 Value
射频输入端口 RF Input Ports	WR-15UG-387/UM
本振/中频端口 LO/IF Ports	SMA Female
本振输入端口 LO Input Ports	SMA Female
中频输出端口 IF Input Ports	SMA Female
供电引脚 Power Supply Pin	FGG 0B 4 Core
尺寸 Size	199mm*68mm* 83mm

绝对最大值 Absolute Maximum Ratings:

参数Parameter	指标 Value
供电偏电压 Supply Bias Voltage	240V
输入功率 Input Power	10dBm

外形尺寸 Outline Drawing:

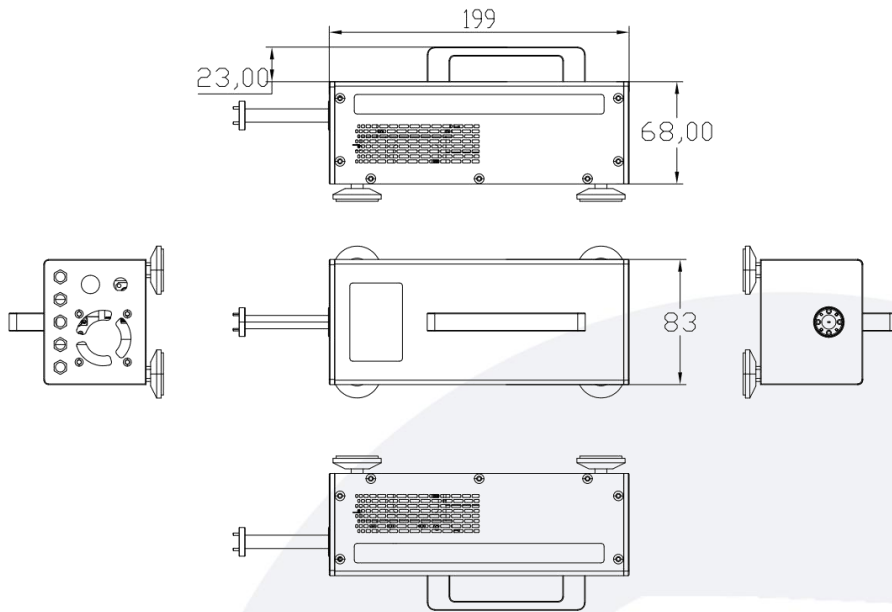

TLSM-050075-06-15

原理框图 Block Diagrams:

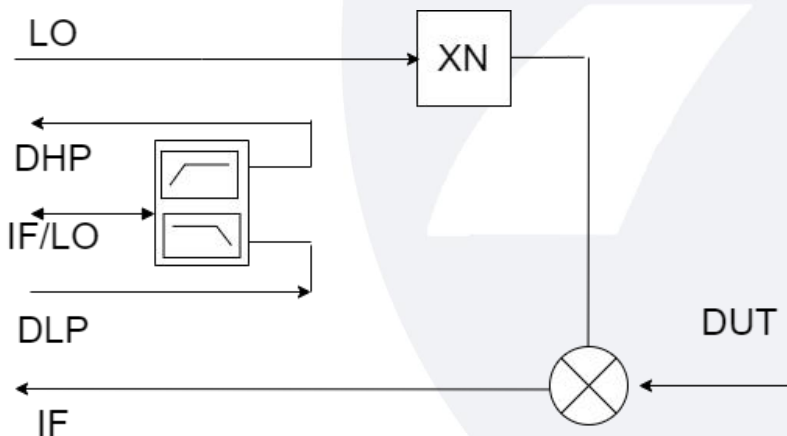

温度环境 Environmental Conditions:

参数Parameter	Min.	Typ.	Max.	单位 Units
操作温度 Operating Temperature	0		+50	°C
存储温度 Non-operating Temperature	-45		+125	°C
相对湿度 Relative humidity		95		%
海拔 Altitude	50,000			feet
震动 Shock / Vibration(MIL-STD-810F)	25g rms (15 degree 2KHz) endurance, 1 hour per axis			
冲击 Shock(non operating)	20G for 11msc half sin wave,3 axis both directions			

订货信息 Ordering Information:

标准型号 Part Number	描述 Description	版本号Revision
TLSM-050075-06-15	V-band Spectrum Frequency Extension Systems, 50-75GHz, Mixer Conversion Loss SSB:8dB	Rev.1.1

随货配件 Components Included :

标准型号 Part Number	描述 Description	数量 Quantity
TLACTDC-22012	AC-to-DC Power Adapter	1 PCS

Notes:

1. Dimensions and specifications may be changed without prior notice.
2. Standard Warranty:three years.