

## Dual Polarized Horn Antenna

2.92mm Female/6-18GHz/20dBi Typ, Gain

Model:TL-60180DPHA20K

TL-60180DPHA20K is a dual polarized horn antenna that operates from 6 to 18GHz, The antenna offers 20dBi typical gain. The antenna VSWR is 1.5:1 typical. The antenna cross pol. isolation is typical 30 dB. The antenna RF ports is 2.92mm female. It can be widely used in EMI detection, orientation, reconnaissance, antenna gain and pattern measurement and other application fields.

### Features:

- Operating Frequency 6 to 18GHz
- Gain: 20dBi Typ
- Dual Linear Polarization

### Applications:

- Radar Systems
- Communication Systems

### Electrical Characteristics:



Parameter	Min	Typ	Max	Units
Frequency Range	6		18	GHz
Gain		20		dBi
Polarization mode	Dual Linear			
Input VSWR		1.5		:1
Cross Pol. Isolation		30		dB
Power Handling	CW: 20 Typ; Peak: 40 Typ			W

### Physical Characteristics:

Description	Parameter	Units
Finish	Paint Black	
Connectors	2.92mm Female	
Size	235.5* $\phi$ 125.2	mm
Weight	0.456	Kg

**Outline Drawing:**

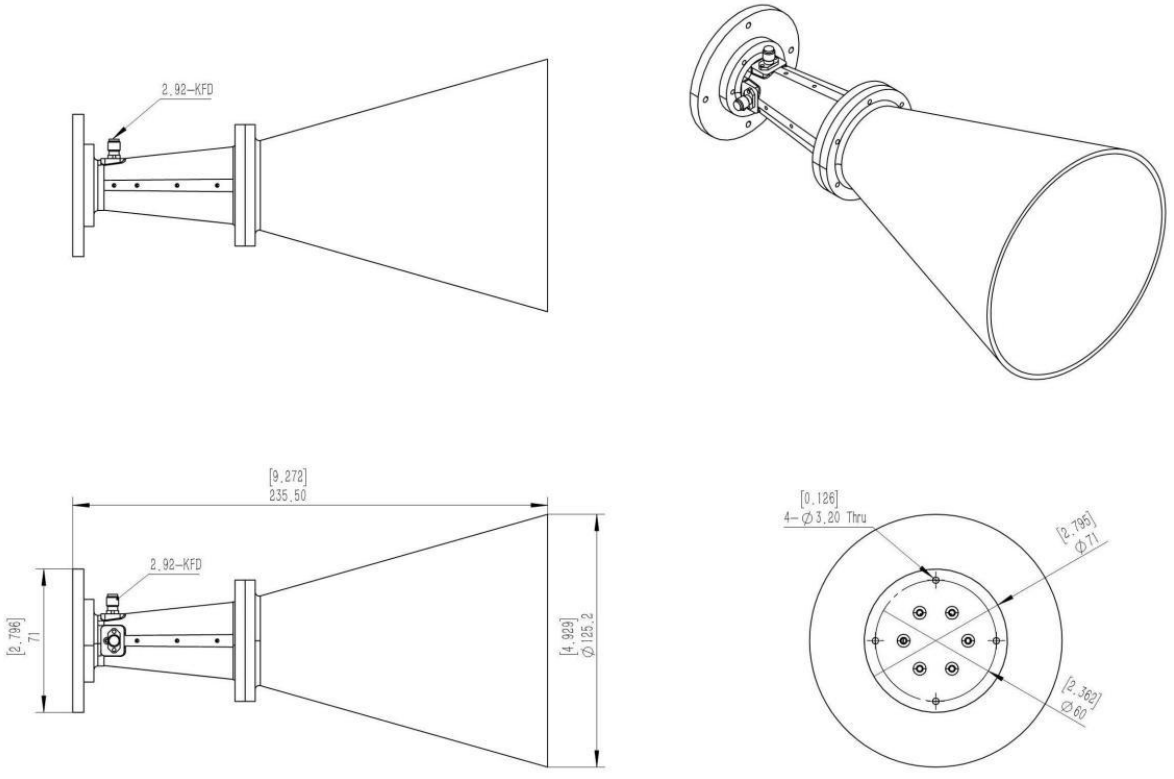
Unit:mm

ESD Protection: Strictly adhere to ESD precautions to prevent electrostatic damage.

**Ordering Information:**

Base Number	Description	Revision
TL-60180DPHA20K	Dual Polarized Horn Antenna, 6-18GHz, Gain: 20dBi Typ, 2.92mm Female	Rev.1.1

**Typical Performance Data:**

**VSWR&Isolation vs Frequen**

VSWR&Isolation(dB)

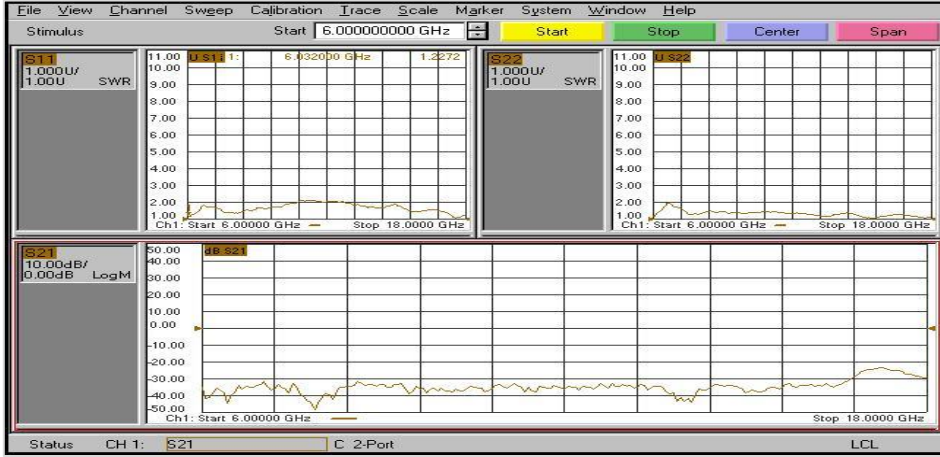

Frequency(GHz)

**Gain vs Frequency**

Gain(dBi)

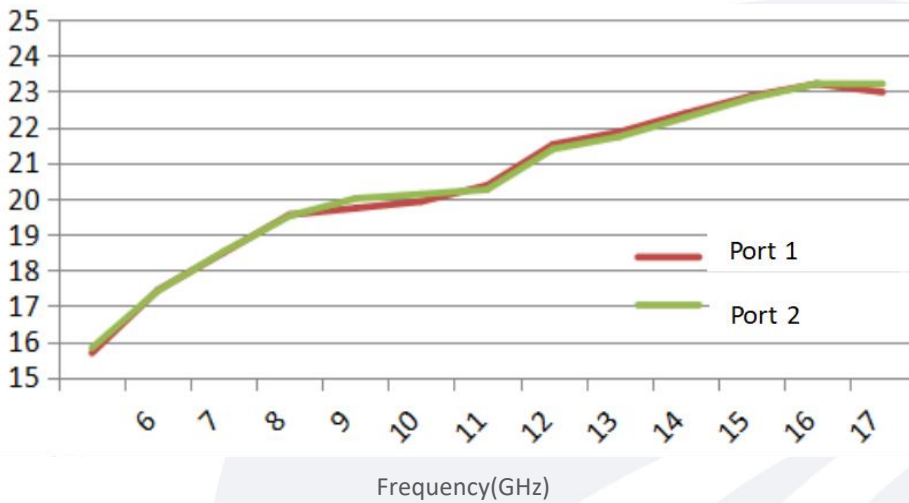

Frequency(GHz)

Port 1:

**Port Isolation vs Frequency**

Isolation(dB)

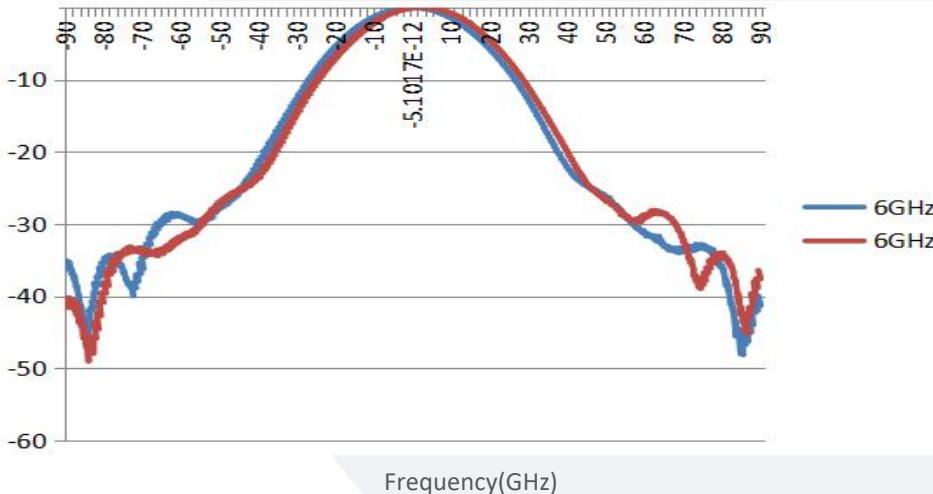

Frequency(GHz)

Note: Above data is for ref only, actual data may vary from unit to unit depending on operating environment and other factors like material lots etc.

**Typical Performance Data:**

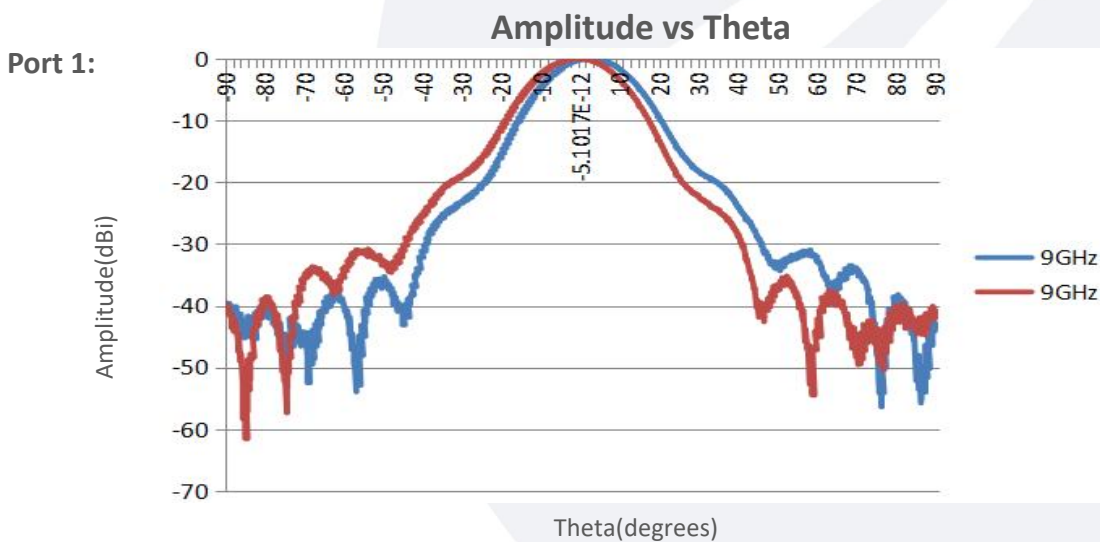
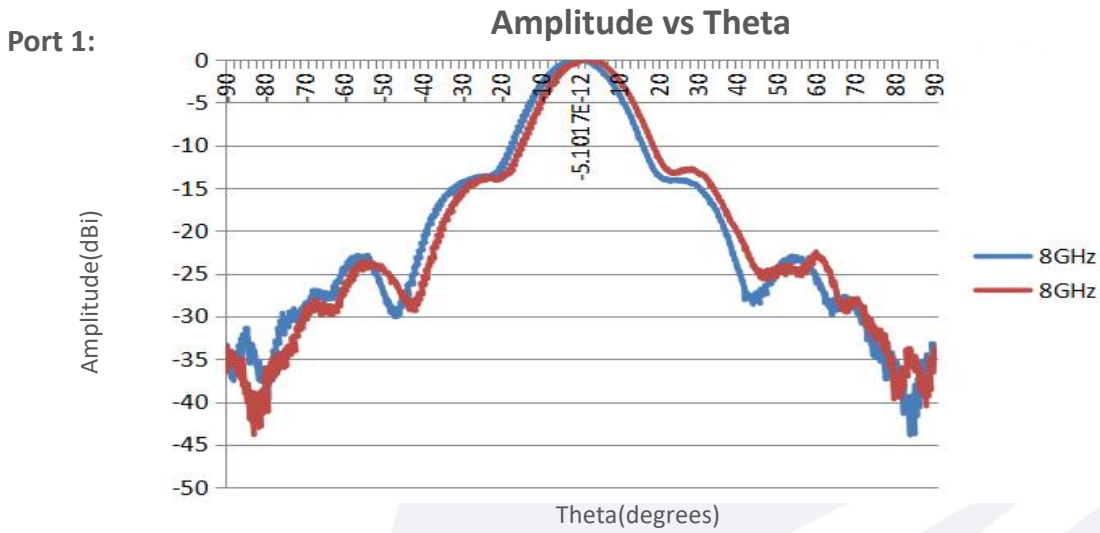
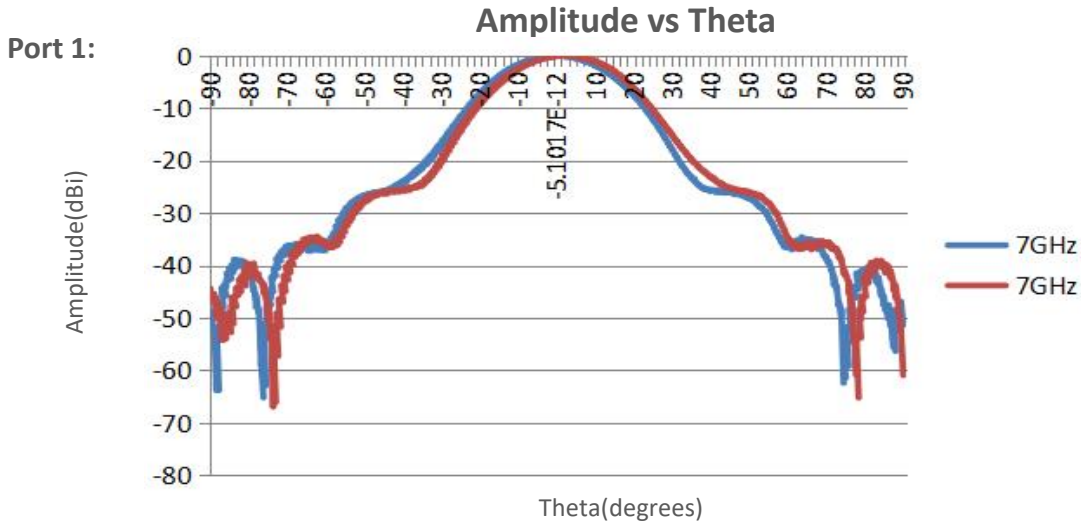

Note: Above data is for ref only, actual data may vary from unit to unit depending on operating environment and other factors like material lots etc.

## Typical Performance Data:

Port 1:

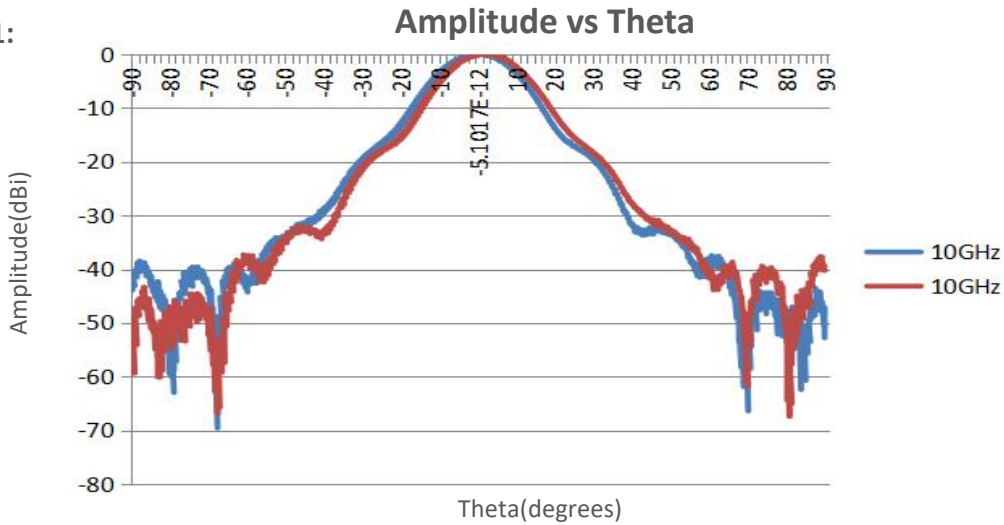

Port 1:

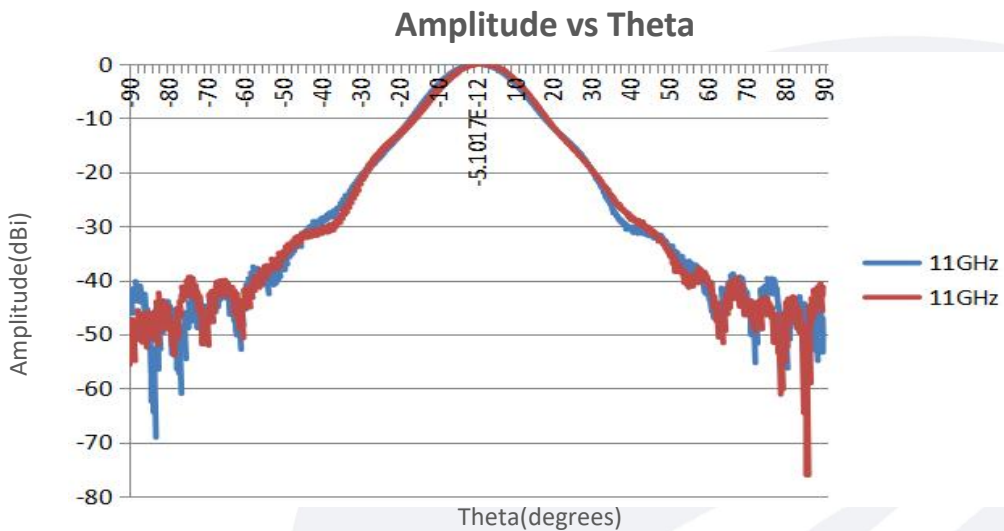

Port 1:

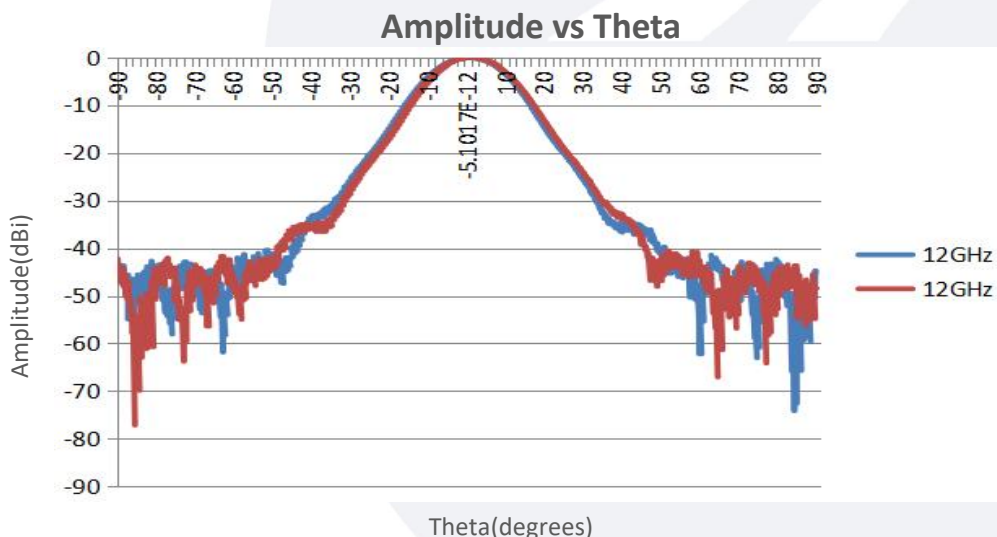

Note: Above data is for ref only, actual data may vary from unit to unit depending on operating environment and other factors like material lots etc.

**Typical Performance Data:**

Port 1:

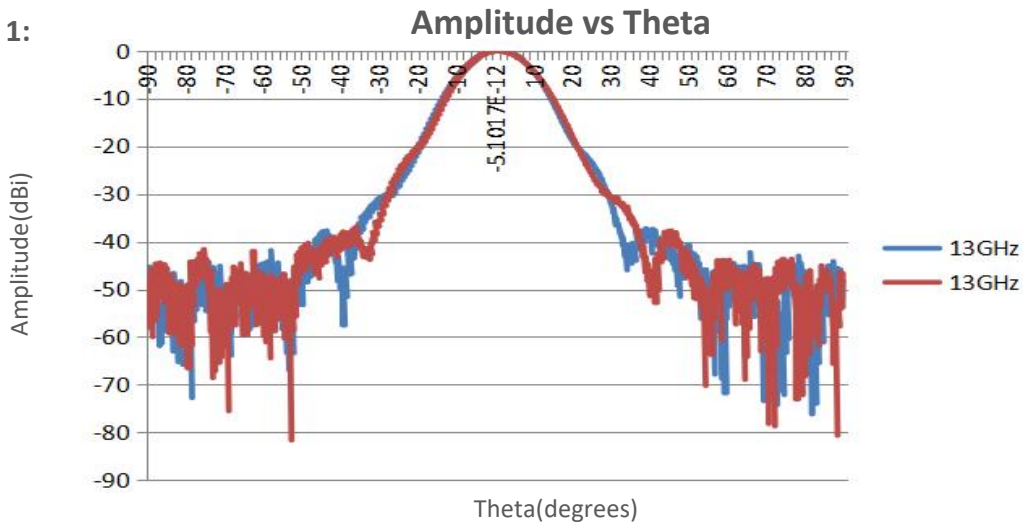

Port 1:

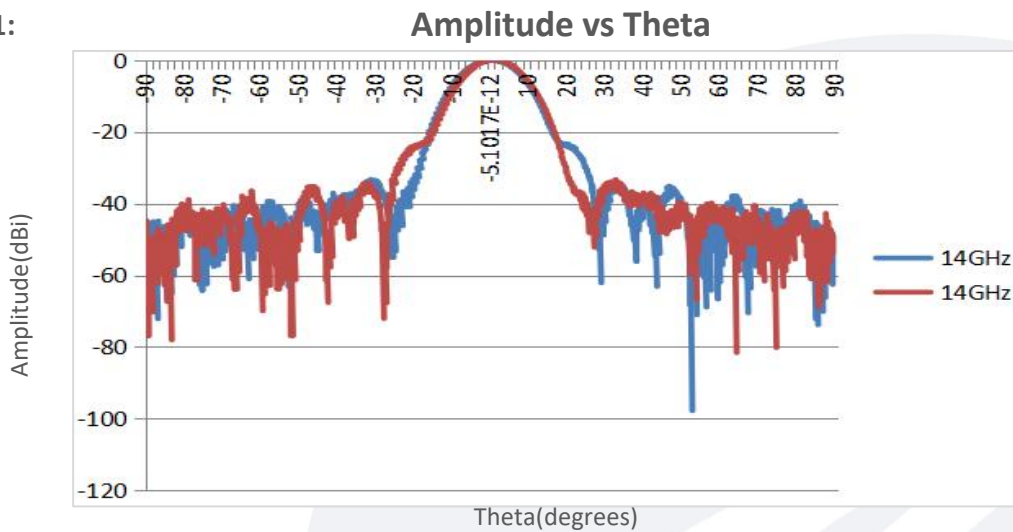

Port 1:

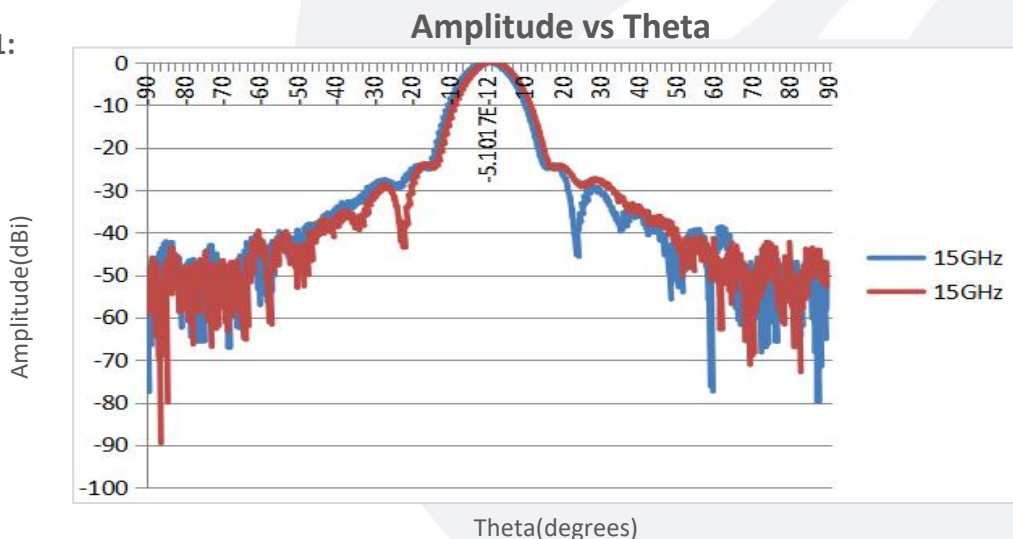

Note: Above data is for ref only, actual data may vary from unit to unit depending on operating environment and other factors like material lots etc.

**Typical Performance Data:**

Port 1:

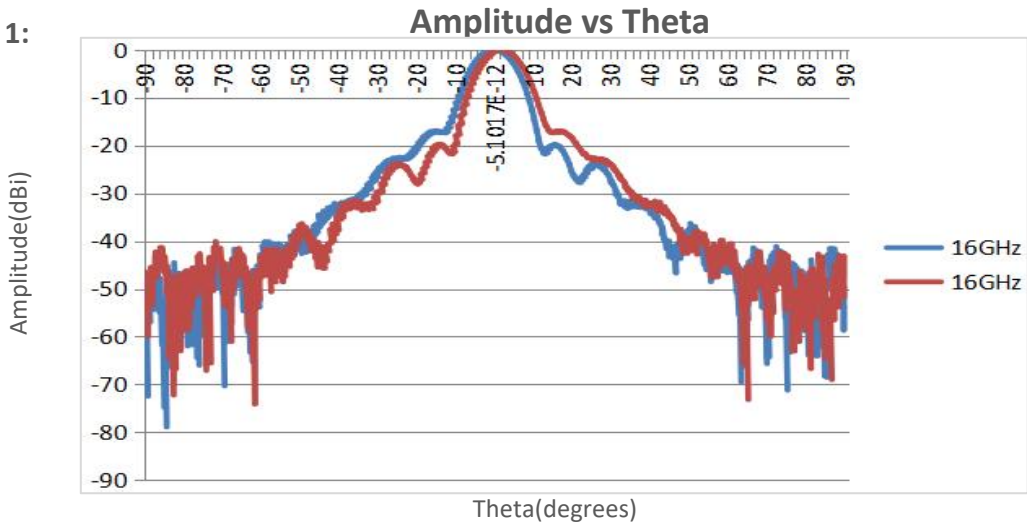

Port 1:

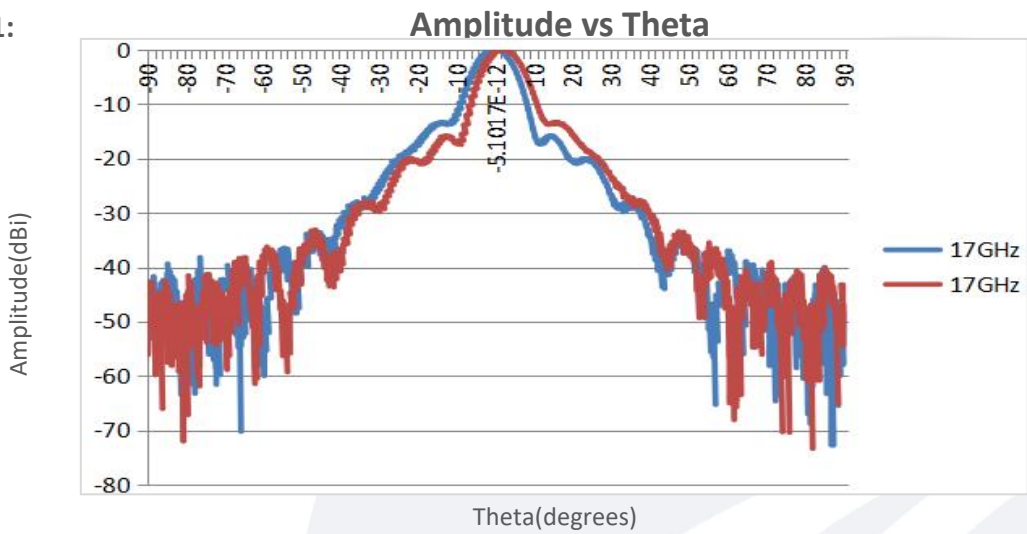

Port 1:

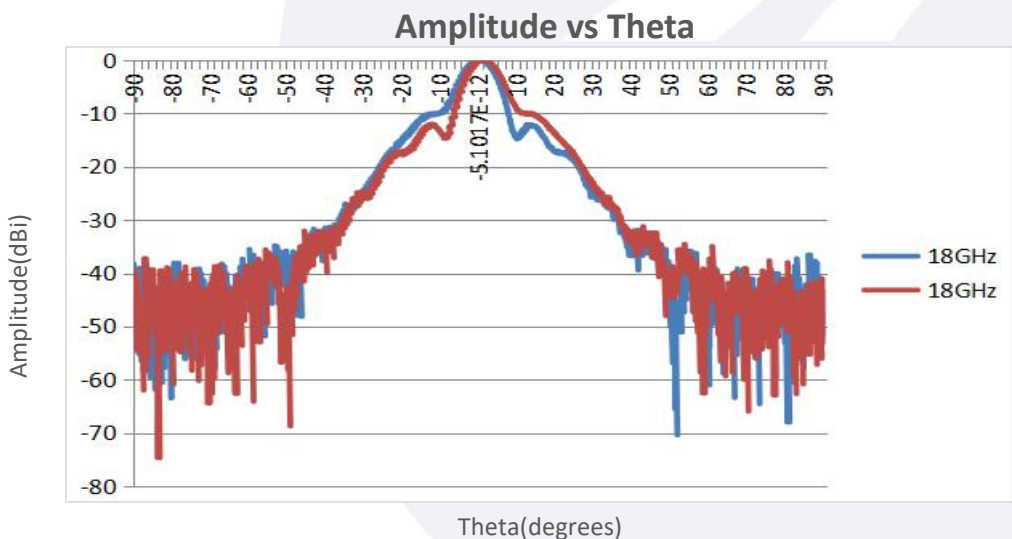

Note: Above data is for ref only, actual data may vary from unit to unit depending on operating environment and other factors like material lots etc.

**Typical Performance Data:**

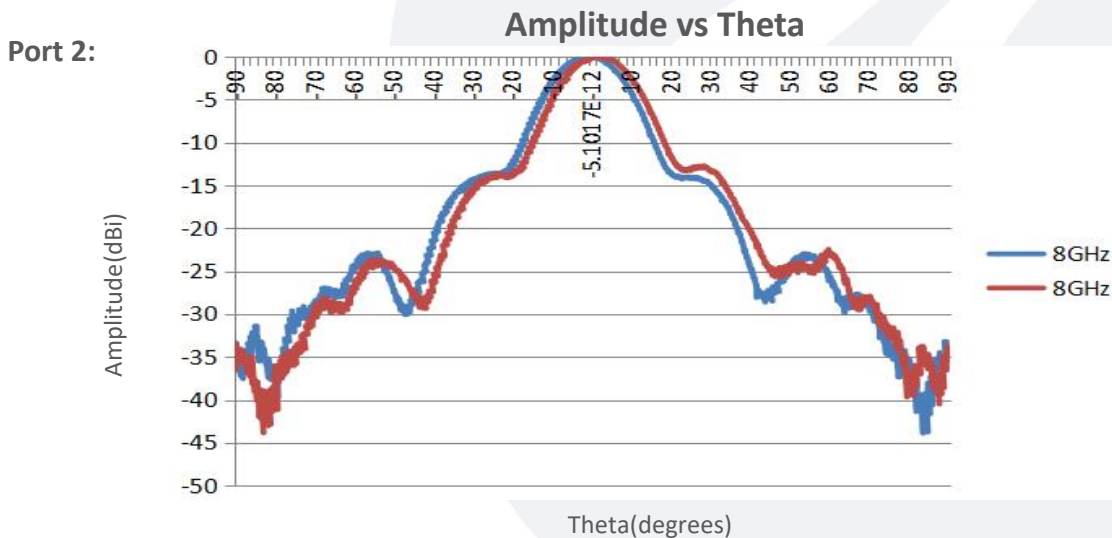
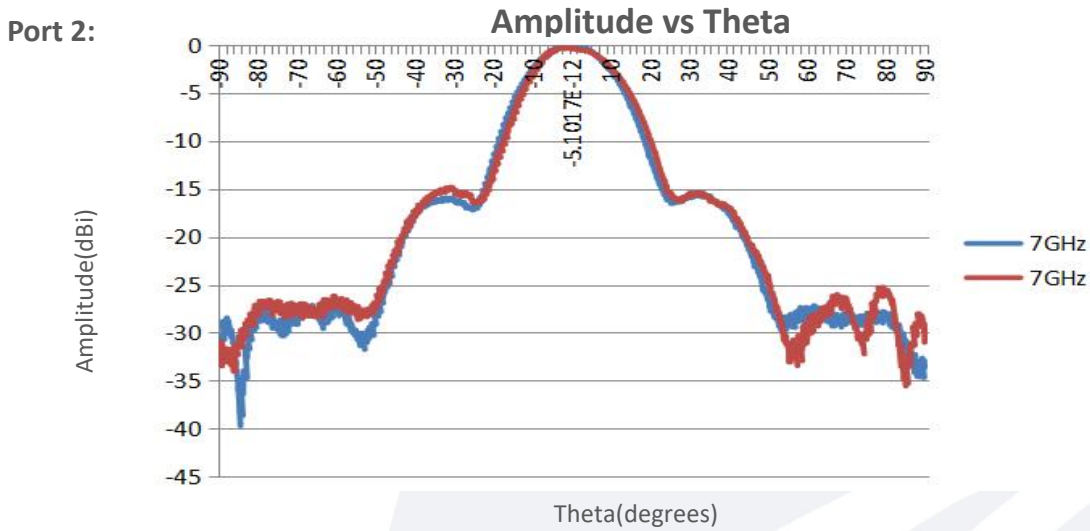
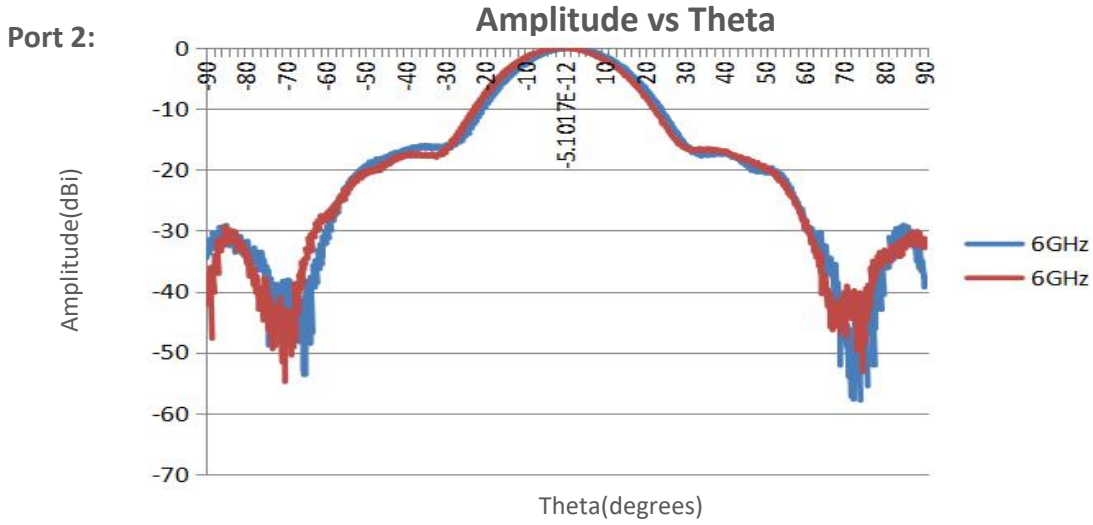

Note: Above data is for ref only, actual data may vary from unit to unit depending on operating environment and other factors like material lots etc.

**Typical Performance Data:**

Port 2:

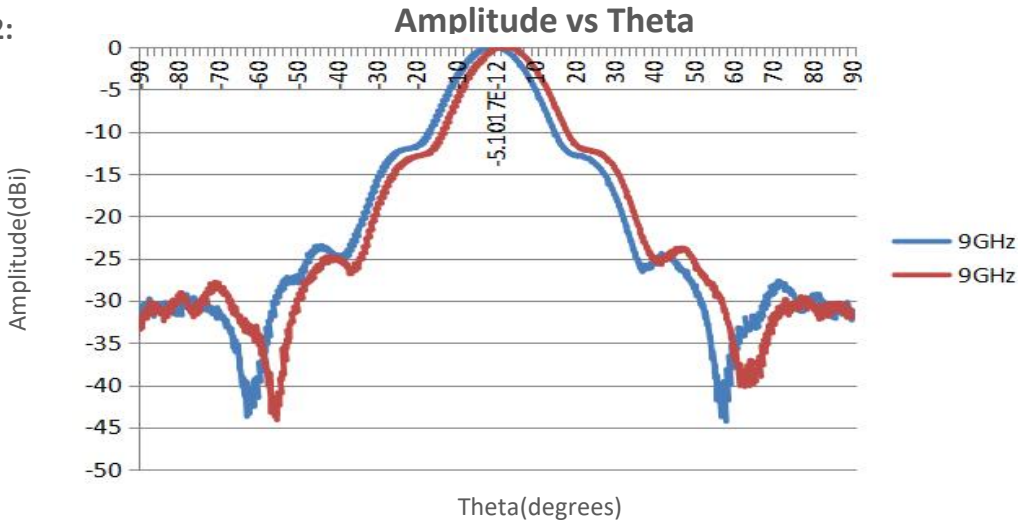

Port 2:

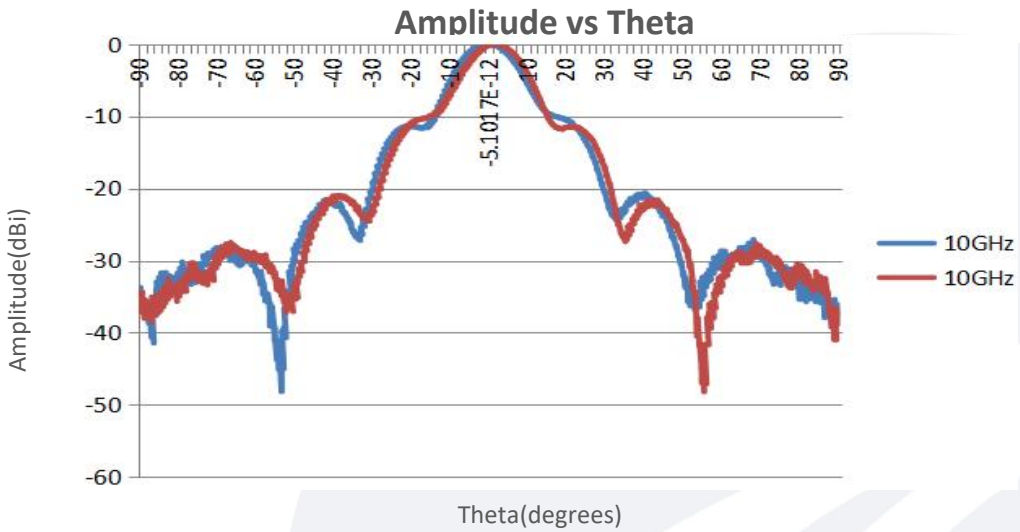

Port 2:

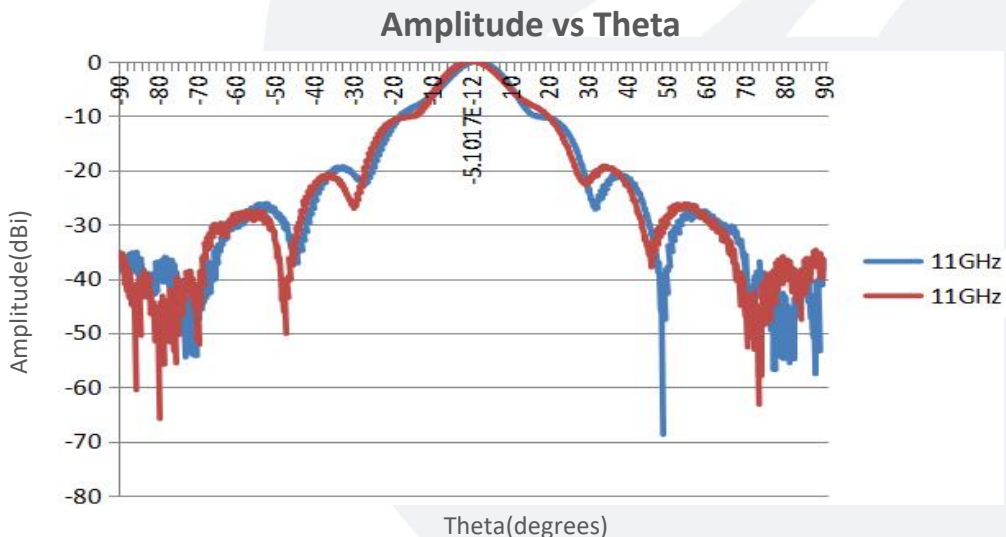

Note: Above data is for ref only, actual data may vary from unit to unit depending on operating environment and other factors like material lots etc.

**Typical Performance Data:**

Port 2:

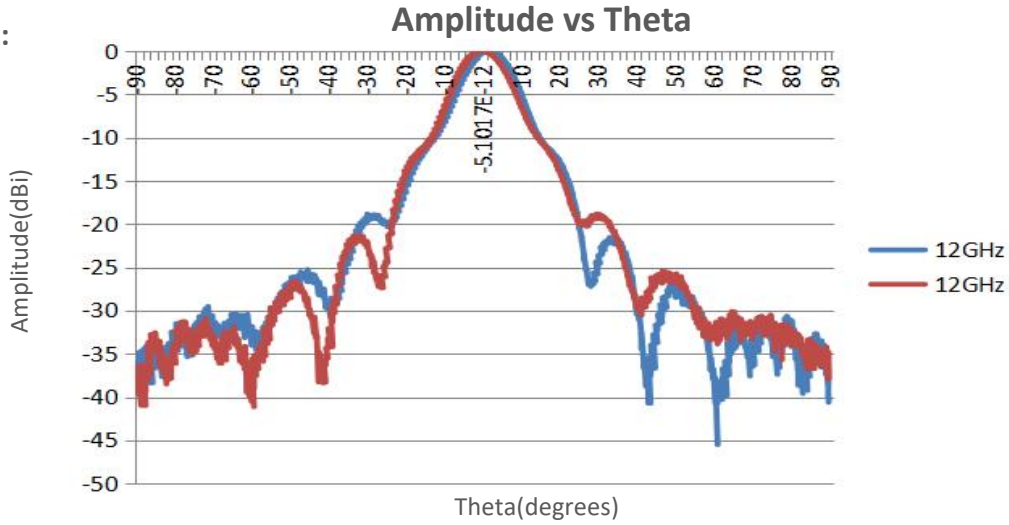

Port 2:

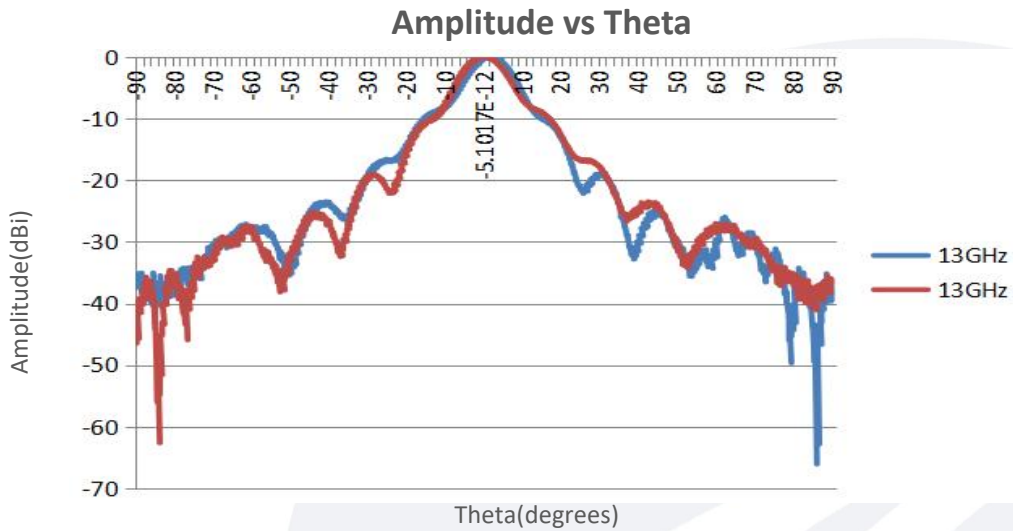

Port 2:

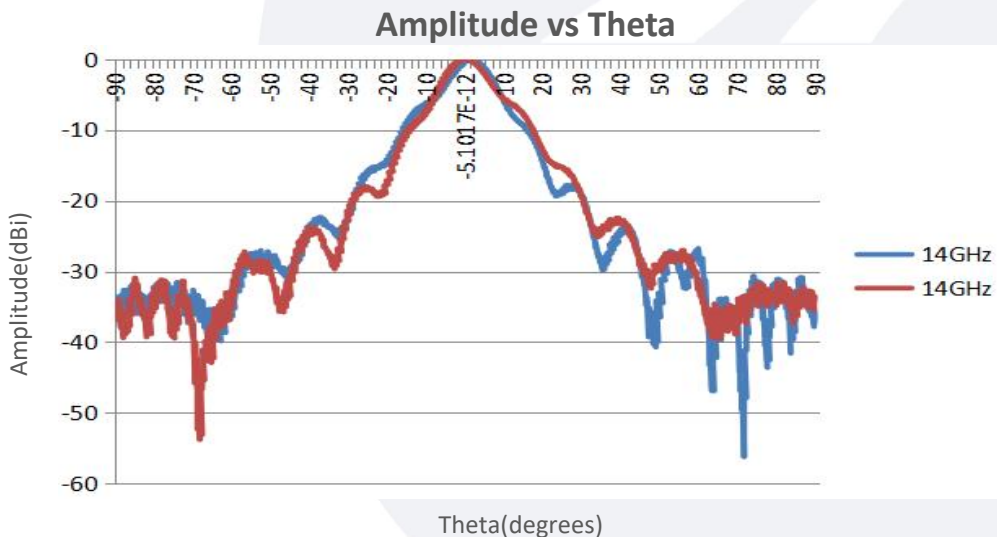

Note: Above data is for ref only, actual data may vary from unit to unit depending on operating environment and other factors like material lots etc.

**Typical Performance Data:**

Port 2:

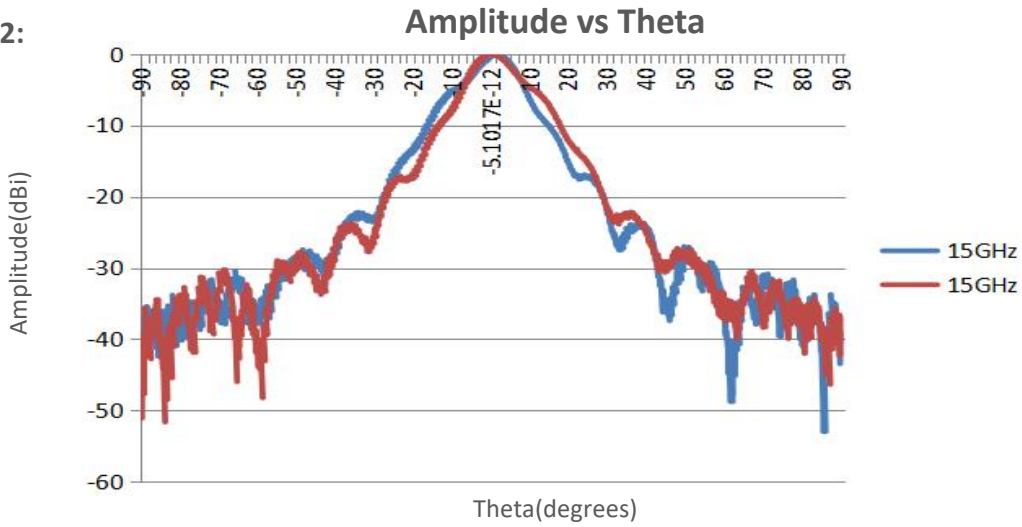

Port 2:

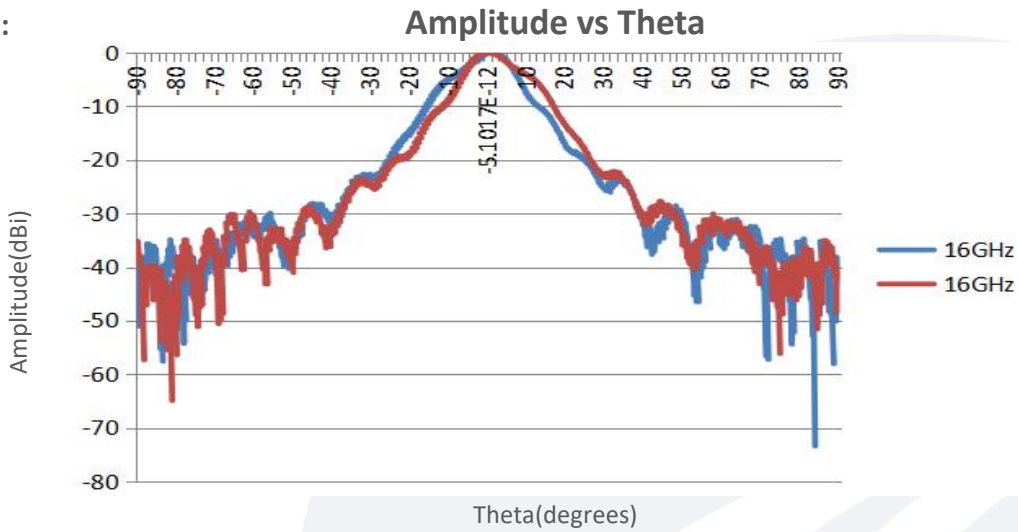

Port 2:

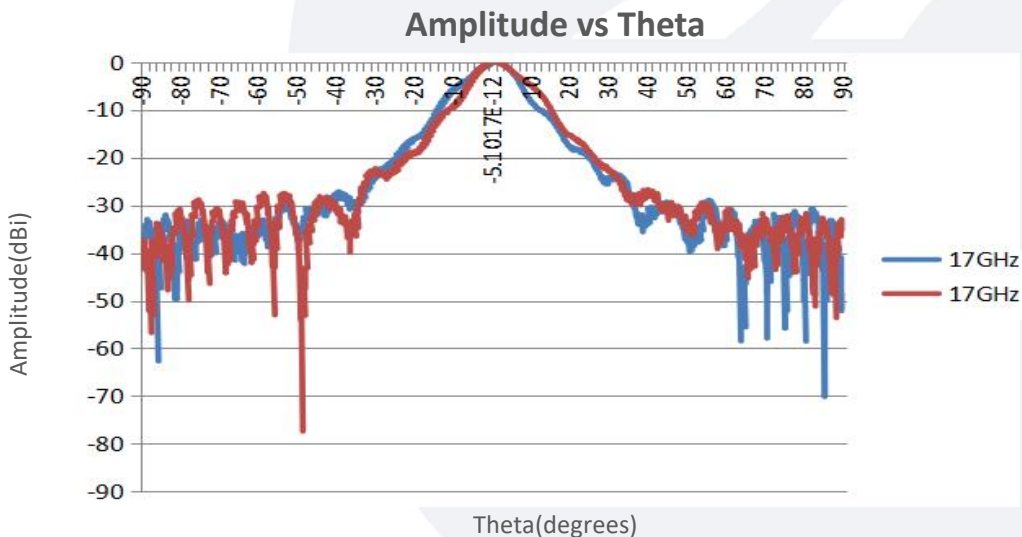

Note: Above data is for ref only, actual data may vary from unit to unit depending on operating environment and other factors like material lots etc.

**Typical Performance Data:**

Port 2:

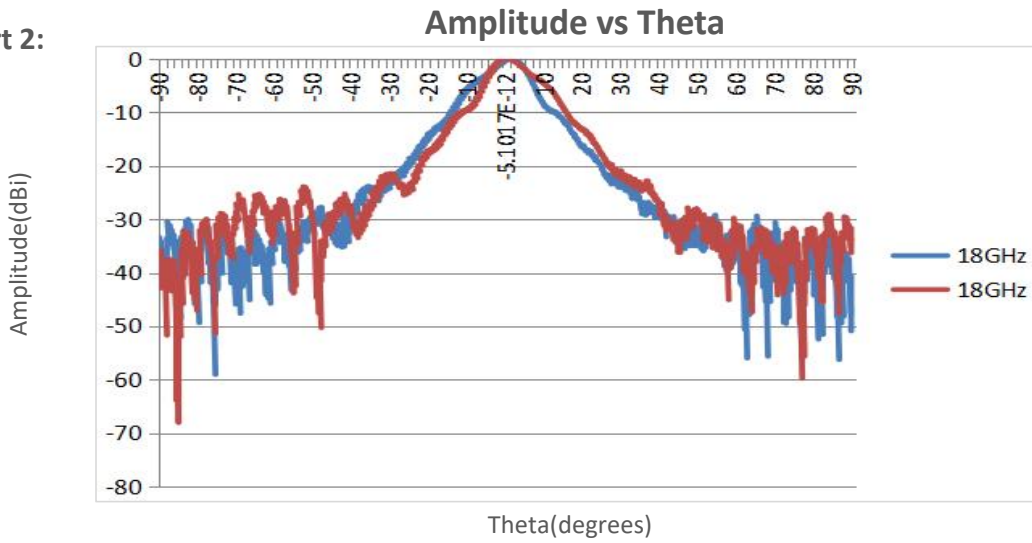

Note: Above data is for ref only, actual data may vary from unit to unit depending on operating environment and other factors like material lots etc.