

**Part No : RT5000-2G-DIN**

DC-2GHz,5000W,DIN Female Coaxial Fixed Terminations

**Electrical Specifications:**

Frequency Range:	DC-2 GHz
VSWR:	≤1.4@Max
RF Power Handling:	≤5000Watts
Impedance:	50 Ohms

**Mechanical Specifications:**

Operation Temperature:	-40°C - +45°C
Storage Temperature:	-40°C - +45°C
Body Material:	Nickel plated Brass
Center Conductor:	Male: Brass,Golden
Connectors:	DIN Female
Relative Humidity:	0-90%

**Outline Drawing:**

Unit: mm

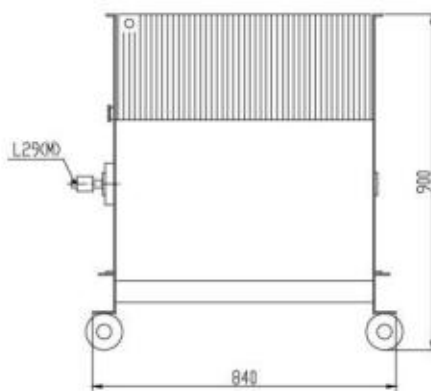

**Ordering Information:**

Part Number	Description
RT5000-2G-DIN	DC-2GHz,5000W, DIN FeMale Coaxial Fixed Termination