

Model: TLSM-220330-18-03
**Spectrum Frequency Extension Systems
 220-330 GHz,WR-03**
Feature:

- Ultra Wide Band: 220-330 GHz
- Low conversion loss
- Unconditional stability
- High performance alternative to harmonic mixers

Electrical Specifications :

Parameter	Min.	Typ.	Max.	Units
Frequency range	220		330	GHz
IF Output Frequency	DC		5	GHz
LO Input Frequency	12.22		18.33	GHz
LO Multiplication Factor		18		
Mixer Conversion Loss SSB		15		dB
LO Input Power	3	7	10	dBm
RF Input Power		-10	0	dBm

Mechanical Specifications :

Parameter	Value
RF Input Ports	WR-03/UG-387/UM
LO/IF Ports	SMA Female
LO Input Ports	SMA Female
IF Input Ports	SMA Female
Power Supply Pin	FGG 0B 4 Core
Size	199mm*68mm* 83mm

Absolute Maximum Ratings:

Parameter	Value
Supply Bias Voltage	240V
Input Power	10dBm

Outline Drawing:

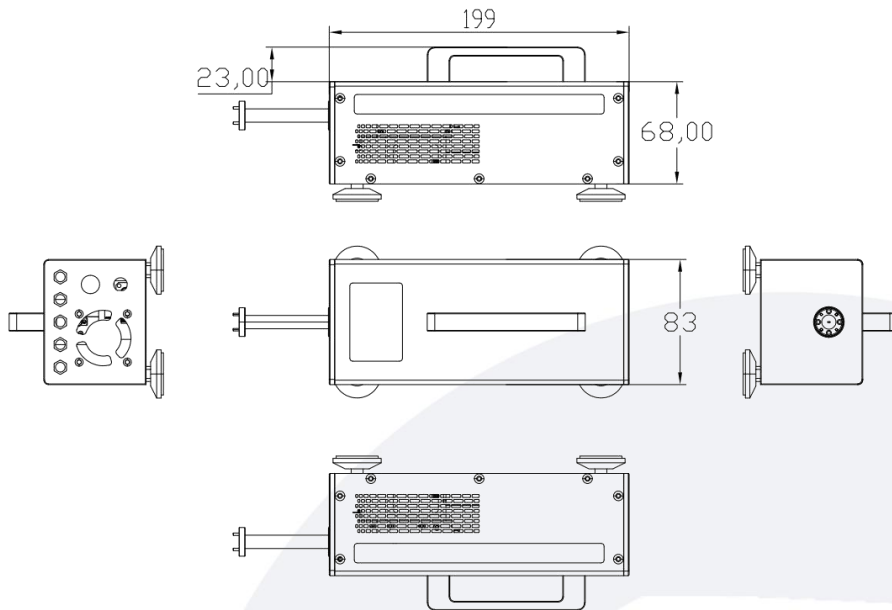

TLSM-220330-18-03

Block Diagrams:

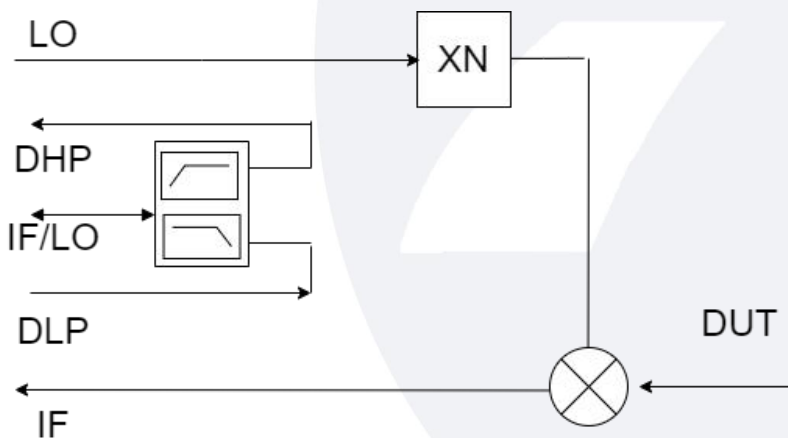

Environmental Conditions:

Parameter	Min.	Typ.	Max.	Units
Operating Temperature	0		+50	°C
Non-operating Temperature	-45		+125	°C
Relative humidity		95		%
Altitude	50,000			feet
Shock / Vibration(MIL-STD-810F)	25g rms (15 degree 2KHz) endurance, 1 hour per axis			
Shock(non operating)	20G for 11msc half sin wave,3 axis both directions			

Ordering Information:

Part Number	Description	Revision
TLSM-220330-18-03	Spectrum Frequency Extension Systems, 220-330GHz, Mixer Conversion Loss SSB:15dB	Rev.1.1

Components Included :

Part Number	Description	Quantity
TLACTDC-22012	AC-to-DC Power Adapter	1 PCS

Notes:

1. Dimensions and specifications may be changed without prior notice.
2. Standard Warranty:three years.