

S Series Low Loss Phase Stable Cable

02

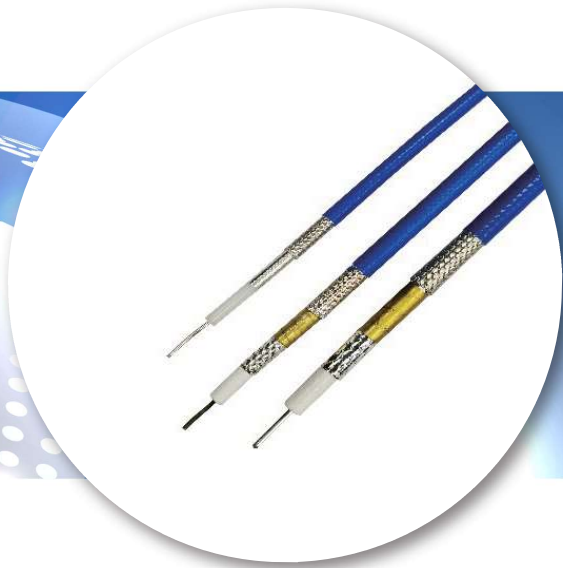

INTRODUCTION

S series uses low-density PTFE tape, silver plated flat wire braided and three layers of shielding. It is widely used in commercial aircraft, testing and measurement applications. After many years of practical application, this series cable has reliable performance, good environmental adaptability, excellent durability and long service life.

Typical Application

- Test cable
- Phase array radar
- Aerospace
- EMC test
- High-power

Features

- Operating frequency up to 50GHz
- High power
- Low loss
- Good shielding
- High mechanical stability

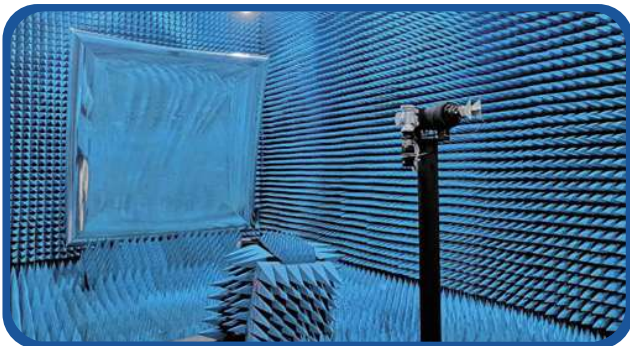

Replacement Table

Talent Model	Replacement Model	Replacement Brand
S1	SFT-142	TIMES
	32022	ASTROLAB
	HP160S	SEMFLEX
	UFA147A	Micro-coax
	SF-102	Huber+suhner
S2	SFT-205	TIMES
	32055	ASTROLAB
	HP190S	SEMFLEX
	UFA205A	Micro-coax
	SF-104	Huber+suhner
S3	SFT-304	TIMES
	32051	ASTROLAB
	HP305S	SEMFLEX

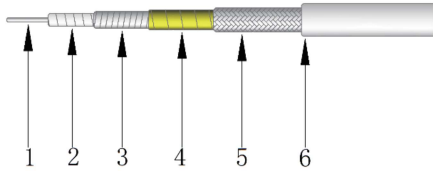

- 1—Center Conductor——SPC
- 2—Dielectric——Low density PTFE
- 3—Outer Conductor——SPC
- 4—Interlayer——PTFE/High Temperature aluminum foil
- 5—Outer Shield——SPC
- 6—FEP Jacket——FEP

Cable Specification

Mode	S0		S1		S2	
Mechanical Specifications						
Center Conductor (mm)	0.72		1.02		1.29	
Dielectric (mm)	2.21		3.03		3.85	
Inner Shield (mm)	2.40		3.32		4.15	
Interlayer (mm)	2.80		3.45		4.28	
Outer Shield (mm)	3.15		4.02		4.73	
Jacket (mm)	3.60		4.60		5.20	
Electrical Specifications						
Impedance(Ω)	50		50		50	
Velocity of Propagation(%)	74		76		76	
Shielding Effectiveness (dB)	< -90		< -100		< -100	
Time Delay (ns/m)	4.50		4.38		4.38	
Capacitance (pF/m)	90.5		88.4		88.0	
Cut-off Frequency(GHz)	48		36		28	
Voltage Withstand(V,DC)	600		800		1000	
Static Bending Radius (mm)	18		23		26	
Dynamic Bending Radius (mm)	36		46		52	
Operating Temperature (°C)	-55~165		-55~200		-55~200	
Attenuation(+25°C Ambient)&Power Handling(+40°C Ambient;SeaLevel;VSWR 1:1)						
Frequency (MHz)	dB/100m	KW	dB/100m	KW	dB/100m	KW
500	30.87	0.580	24.88	0.809	19.44	1.065
1000	43.79	0.409	35.36	0.569	27.67	0.749
2000	62.18	0.288	50.35	0.400	39.47	0.525
4000	88.45	0.202	71.90	0.280	56.52	0.366
6000	108.82	0.165	88.71	0.227	69.87	0.296
8000	141.47	0.127	115.85	0.174	91.53	0.255
12000	155.44	0.115	127.53	0.158	100.88	0.205
16000	180.43	0.099	148.52	0.136	117.76	0.176
18000	191.82	0.093	158.14	0.127	125.51	0.165
20000	202.65	0.088	167.30	0.120	132.90	0.156
26500	234.80	0.076	194.63	0.103	155.04	0.134
40000	291.75	0.061				
K1	1.3707349		1.0994853		0.856234	
K2	0.00044		0.0005906		0.0005908	

Mode	S3		S4		S5		S6	
Mechanical Specifications								
Center Conductor (mm)	1.57		2.06		3.50		4.40	
Dielectric (mm)	4.72		5.89		9.90		12.50	
Inner Shield (mm)	5.18		6.05		10.17		12.82	
Interlayer (mm)	5.30		6.17		10.30		12.95	
Outer Shield (mm)	5.80		6.81		11.02		13.67	
Jacket (mm)	6.20		7.62		12.00		14.70	
Electrical Specifications								
Impedance(Ω)	50		50		50		50	
Velocity of Propagation(%)	76		76		76		76	
Shielding Effectiveness (dB)	< -100		< -100		< -100		< -100	
Time Delay (ns/m)	4.38		4.38		4		4.38	
Capacitance (pF/m)	87.4		91.6		92.6		92.2	
Cut-off Frequency(GHz)	23		18		11		8	
Voltage Withstand(V,DC)	1300		1600		2700		3500	
Static Bending Radius (mm)	31		38		60		74	
Dynamic Bending Radius (mm)	62		76		120		147	
Operating Temperature (°C)	-55~200		-55~200		-55~200		-55~200	
Attenuation(+25°C Ambient)&Power Handling(+40°C Ambient;SeaLevel;VSWR 1:1)								
Frequency (MHz)	dB/100m	KW	dB/100m	KW	dB/100m	KW	dB/100m	KW
500	15.55	1.411	12.29	2.19	9.06	3.71	7.10	5.87
1000	22.17	0.99	17.55	1.53	12.99	2.59	10.21	4.08
2000	31.70	0.693	25.17	1.07	18.72	1.80	14.79	2.82
4000	45.52	0.482	36.29	0.74	27.17	1.24	21.60	1.93
6000	56.40	0.389	45.10	0.60	33.94	0.99	27.11	1.54
8000	74.15	0.334	52.71	0.51	39.83	0.84		
12000	81.84	0.268	65.85	0.41				
16000	95.77	0.229	77.31	0.35				
18000	102.19	0.215	82.61	0.33				
K1	0.68243		0.536417		0.39168		0.304208	
K2	0.0005906		0.000591		0.0006		0.000591	

Test Data

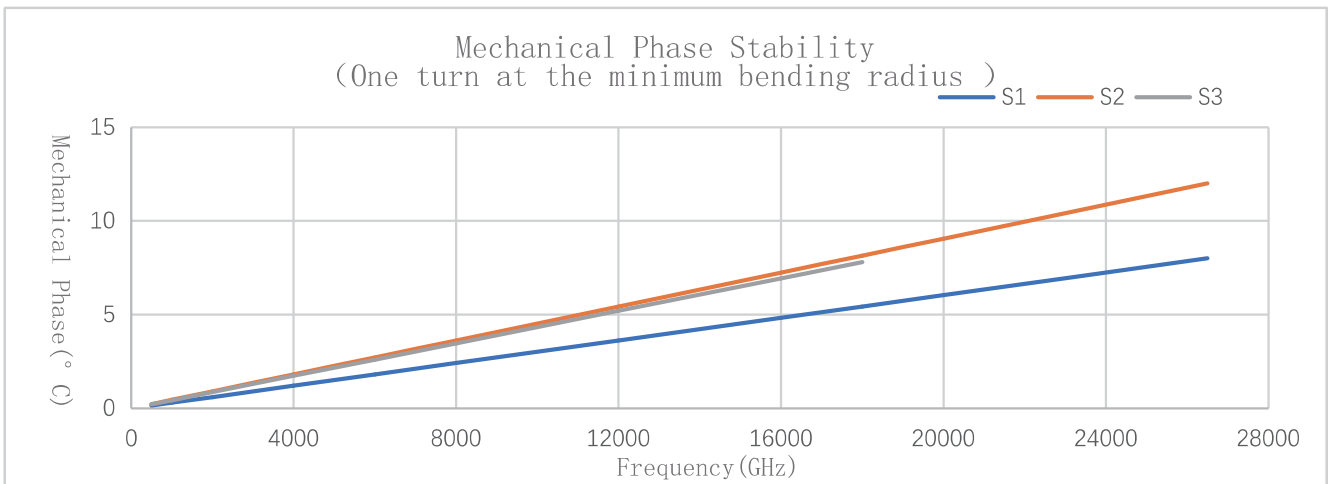
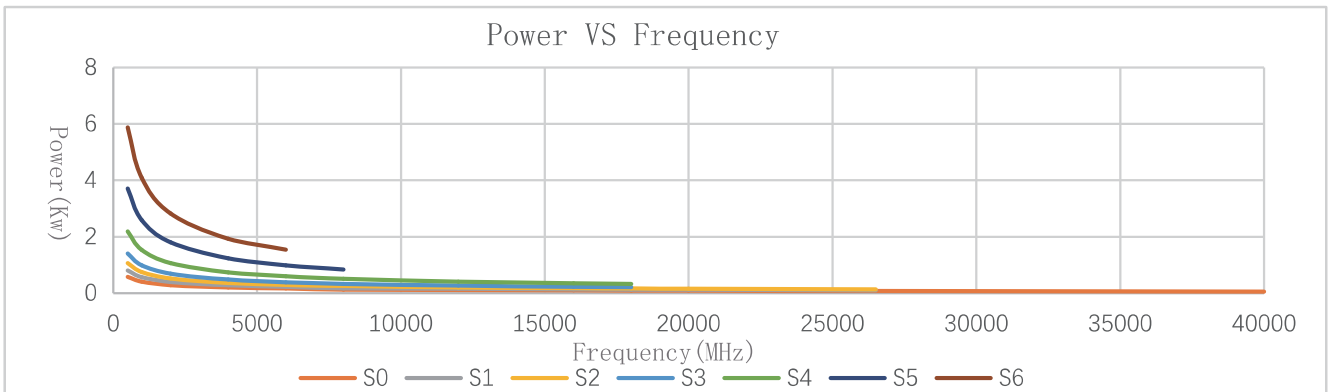
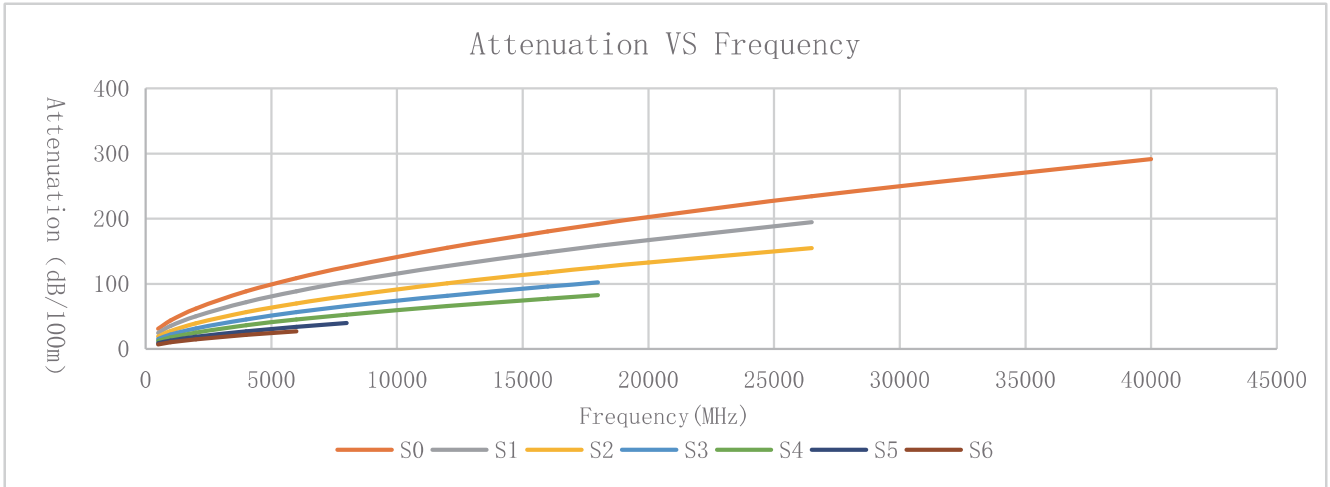

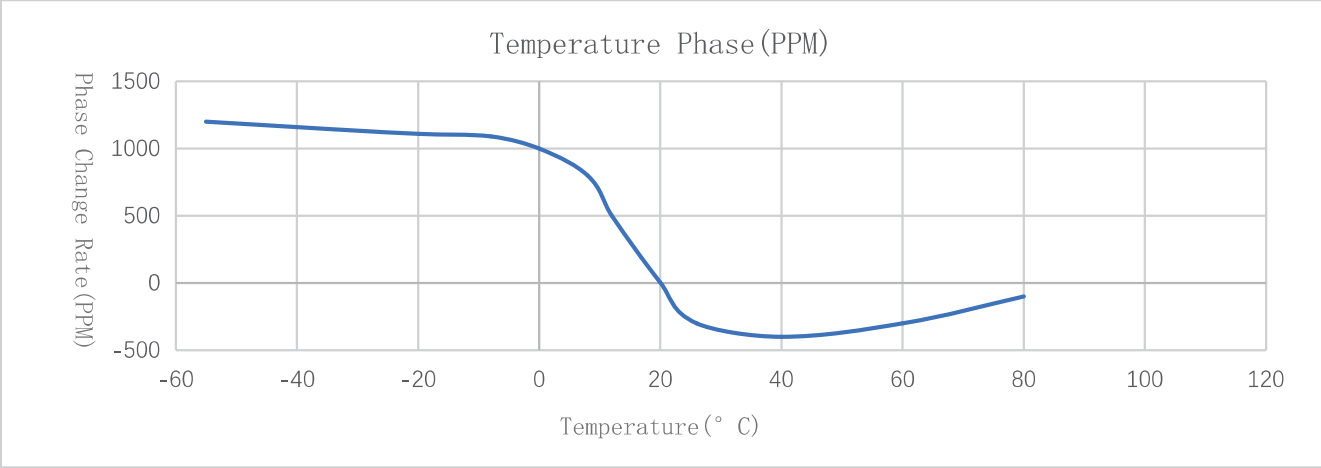
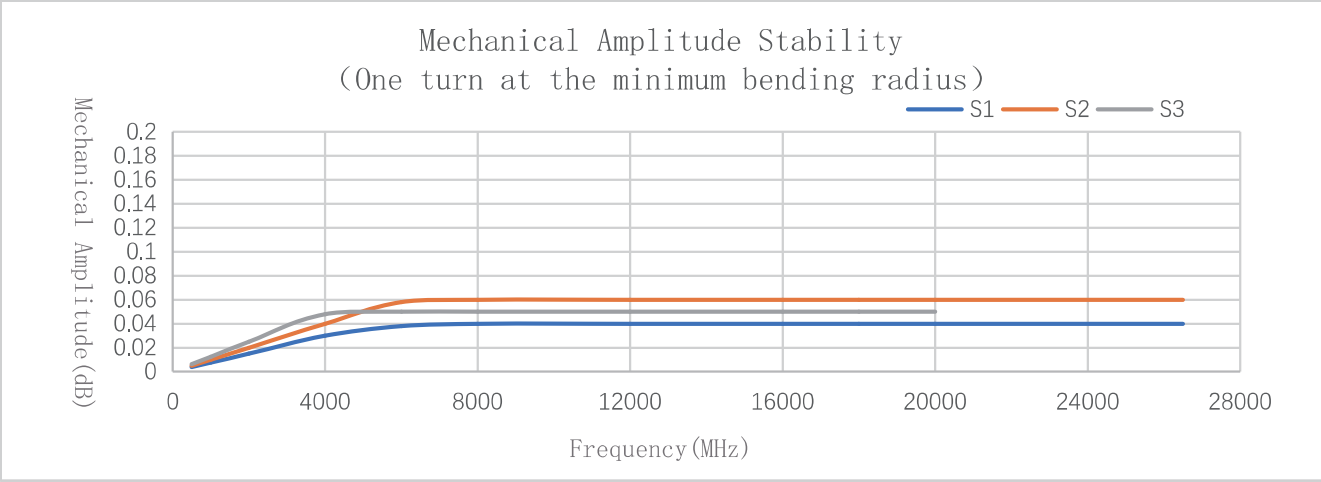

Assembly Selection Information

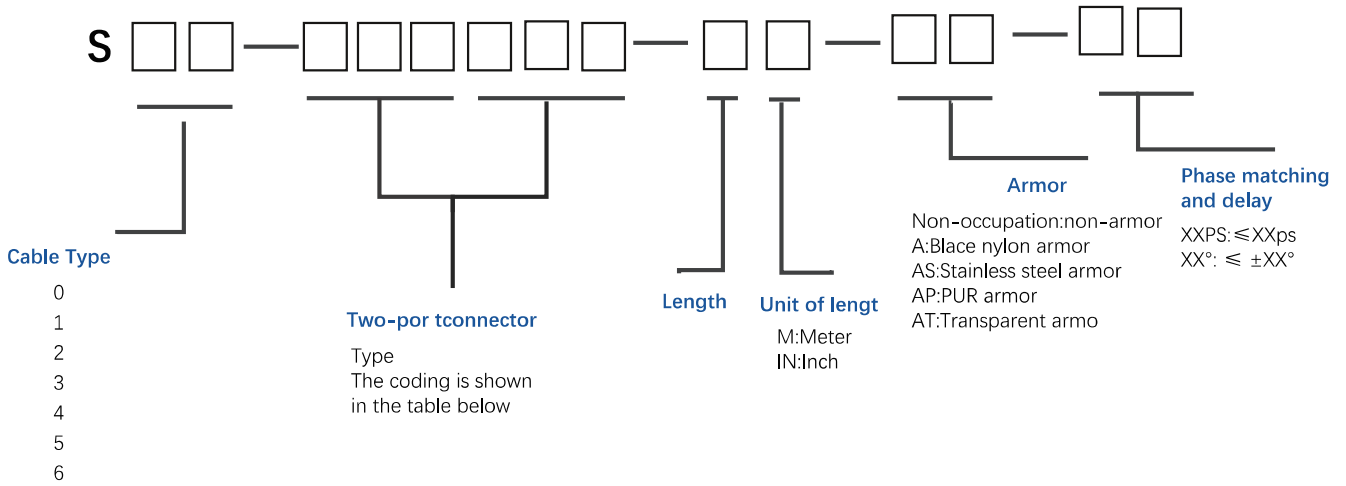

Optional Connectors

Connector Code	Connector Type	Operating Frequency	S0	S1	S2	S3	S4	S5	S6	VSWR (Max)
2.92M	2.92mm Male	DC-40GHz	●							1.30
2.92F	2.92mm Female	DC-40GHz	●							1.30
SMAM	SMA Male	DC-27GHz		●	●	●	●			1.25
SMAWM	SMA Male Right Angle	DC-18GHz		●	●					1.25
SMAF	SMA Female	DC-27GHz		●		●	●			1.25
NM	N Male	DC-18GHz		●	●	●	●	●	●	1.25
NF	N Female	DC-18GHz		●	●	●	●	●	●	1.25
TNCM	TNC Male	DC-12GHz		●				●	●	1.25
SCM	SC Male	DC-6GHz						●	●	1.25
DINM	7/16 Male	DC-6GHz						●	●	1.25