

A Series High-Performance Low Loss Phase Stable Flexible Cable

01



INTRODUCTION

A Series adopts strict production process and control requirements, so that the product has excellent electrical and mechanical performance within its working frequency range; In terms of electrical performance, the signal transmission rate of this series can reach 83%, which makes the cable signal loss as low as possible and the temperature phase stability is less than 550PPM;

In terms of mechanical performance, the strict production technology ensures excellent bending performance; In terms of environmental adaptability, the use of excellent production materials ensures the product used in a wide temperature range and has corrosion resistance, cracking resistance, moisture-proof, mildew-proof and fire resistance characteristics.

Typical Application

- Test cables
- Radar
- Aerospace systems
- Millimeter wave 5G communication
- Lab test

Features

- Operating frequency up to 110GHz
- Extra-low loss
- High power
- High temperature resistance
- Good shielding

Replacement Table

Talent Model	Replacement Model	Replacement Brand
A15	CXN3657	GORE
A22	CXN3506	GORE
A40	CXN3507	GORE
	UFB142	MCC
A48	CXN3449	GORE
A50	UFB205A	MCC
A75	CXN3450	GORE
A81	UFB311A	MCC



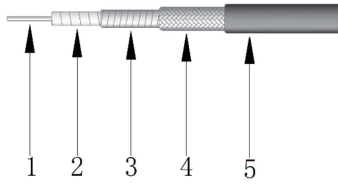

- 1—Center Conductor——SPC
- 2—Dielectric——PTFE
- 3—Inner Shield——SPC
- 4—Outer Shield——SPC
- 5—Jacket——FEP

CABLE SPECIFICATION

Model	A15		A22		A40L		A40		A48			
Mechanical Specifications												
Center Conductor (mm)	0.3		0.51		1.02		0.91		1.4			
Dielectric (mm)	0.8		1.38		3.0		2.45		3.75			
Inner Shield (mm)	0.93		1.58		3.1		2.66		3.95			
Outer Shield (mm)	1.15		1.9		3.35		3.15		4.35			
Jacket (mm)	1.43		2.2		3.7		3.6		4.8			
Electrical Specifications												
Impedance(Ω)	50		50		50		50		50			
Velocity of Propagation(%)	80		82		83		83		83			
Shielding Effectiveness (dB)	< -90		< -90		< -90		< -90		< -90			
Time Delay (ns/m)	4.16		4.06		4.06		4.01		4.01			
Capacitance (pF/m)	81.7		83		79.8		79.8		81.9			
Cut-off Frequency(GHz)	135		83		46		46		31			
Voltage Withstand(V,DC)	200		350		650		650		1000			
Static Bending Radius (mm)	7		11		18		18		24			
Dynamic Bending Radius (mm)	15		22		36		36		48			
Operating Temperature (°C)	-55~125		-55~125		-55~165		-55~125		-55~125			
Attenuation(+25°C Ambient)&Power Handling(+40°C Ambient;SeaLevel;VSWR 1:1)												
Frequency (MHz)	dB/100m		KW		dB/100m		KW		dB/100m		KW	
500	91.06		0.047		44.79		0.079		16.75		0.960	
1000	128.94		0.033		63.70		0.055		31.91		0.511	
2000	182.69		0.024		90.80		0.039		45.45		0.359	
4000	259.04		0.017		129.85		0.027		64.93		0.251	
6000	317.89		0.014		160.37		0.022		80.13		0.203	
8000	367.69		0.012		186.49		0.019		91.15		0.176	
12000	451.59		0.010		231.09		0.015		115.28		0.142	
16000	522.69		0.008		269.46		0.013		134.30		0.122	
18000	554.98		0.008		287.06		0.012		143.02		0.115	
20000	585.60		0.007		303.84		0.012		151.31		0.110	
26500	676.07		0.006		354.00		0.010		176.12		0.093	
40000	834.90		0.005		444.01		0.008		220.51		0.074	
50000	936.48		0.005		502.86		0.007					
67000	1089.31		0.004		593.24		0.006					
110000	1409.66		0.003									
K1	4.0594		1.975832		0.991550		1.16847		0.734593			
K2	0.0005755		0.001221		0.000555		0.00055		0.00044			

Mode	A50		A75		A81		A120	
Mechanical Specifications								
Center Conductor (mm)	1.45		2.1		2.3		3.80	
Dielectric (mm)	4		5.75		6.25		10.40	
Inner Shield (mm)	4.2		6.07		6.57		10.78	
Outer Shield (mm)	4.7		6.58		7.15		11.35	
Jacket (mm)	5.1		7.50		7.80		12.00	
Electrical Specifications								
Impedance(Ω)	50		50		50		50	
Velocity of Propagation(%)	83		83		83		83	
Shielding Effectiveness(dB)	< -90		< -90		< -90		< -90	
Time Delay (ns/m)	4.01		4.01		4.01		4.01	
Capacitance (pF/m)	79.5		80.1		80.1		80.1	
Cut-off Frequency(GHz)	29		20		18		11	
Voltage Withstand(V,DC)	1100		1600		1700		2900	
Static Bending Radius (mm)	26		38		39		60	
Dynamic Bending Radius (mm)	51		75		78		120	
Operating Temperature (°C)	-55~125		-55~125		-55~125		-55~125	
Attenuation(+25°C Ambient)&Power Handling(+40°C Ambient;SeaLevel;VSWR 1:1)								
Frequency (MHz)	dB/100m	KW	dB/100m	KW	dB/100m	KW	dB/100m	KW
500	16.17	1.243	10.88	2.474	10.37	2.633	6.94	4.372
1000	22.96	0.875	15.43	1.744	14.76	1.850	9.98	3.043
2000	32.66	0.615	21.93	1.227	21.07	1.296	14.42	2.105
4000	46.58	0.431	31.21	0.862	30.18	0.905	21.02	1.444
6000	57.40	0.350	38.42	0.700	37.32	0.732	26.34	1.153
8000	66.66	0.268	44.55	0.604	43.44	0.558	30.98	0.980
12000	82.34	0.244	54.94	0.490	53.93	0.506		
16000	95.78	0.210	63.81	0.422	62.98	0.434		
18000	101.92	0.197	67.86	0.397	67.13	0.407		
20000	107.77	0.186						
26500	125.20	0.161						
K1	0.715987		0.48249		0.45638		0.298565	
K2	0.000328		0.000174		0.000328		0.000535	



Test Data

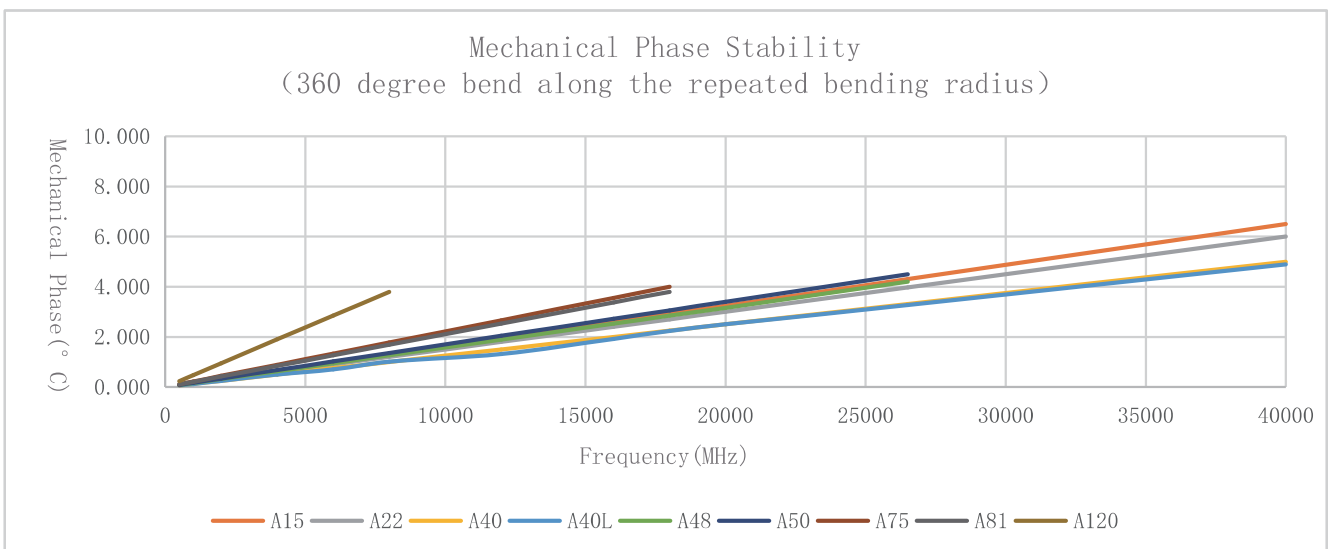
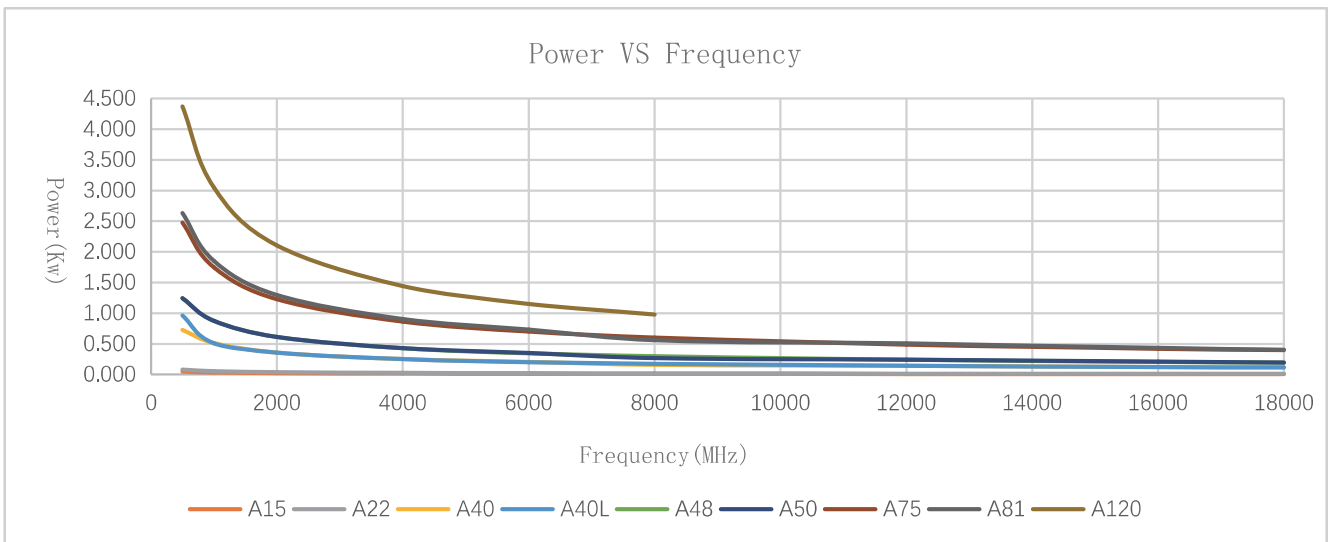
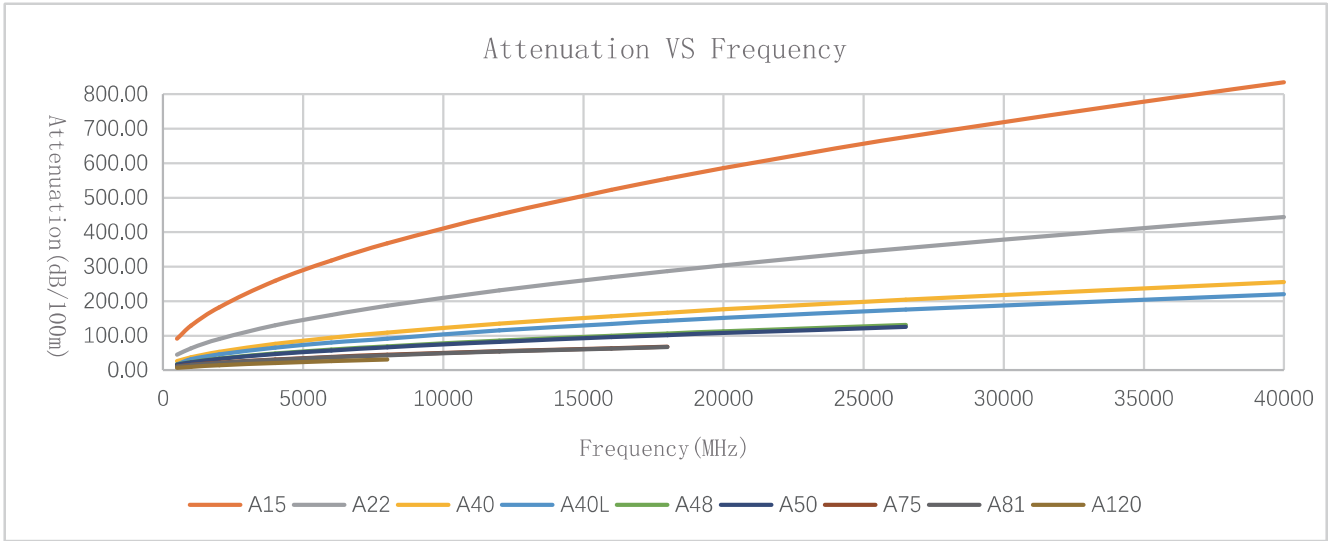

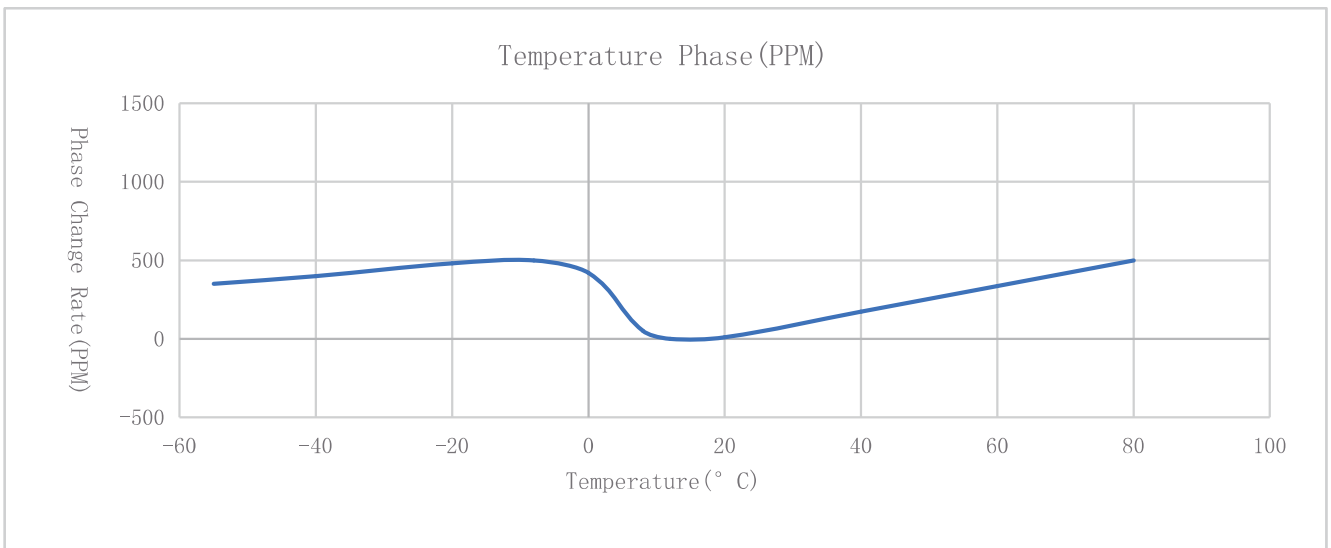
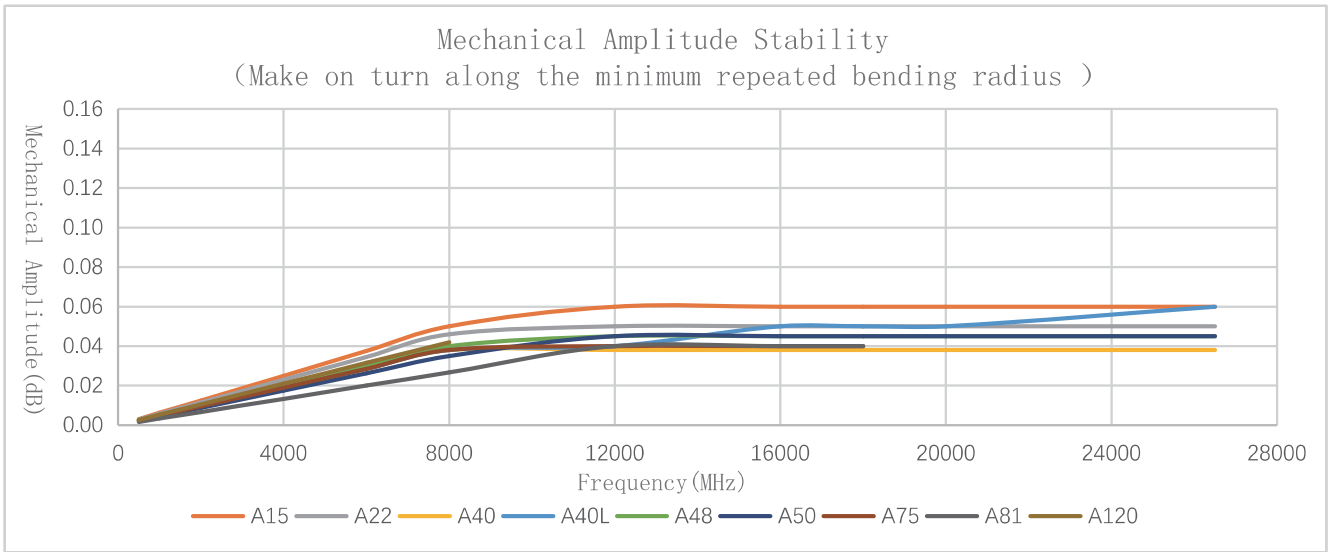

Assembly Selection Information

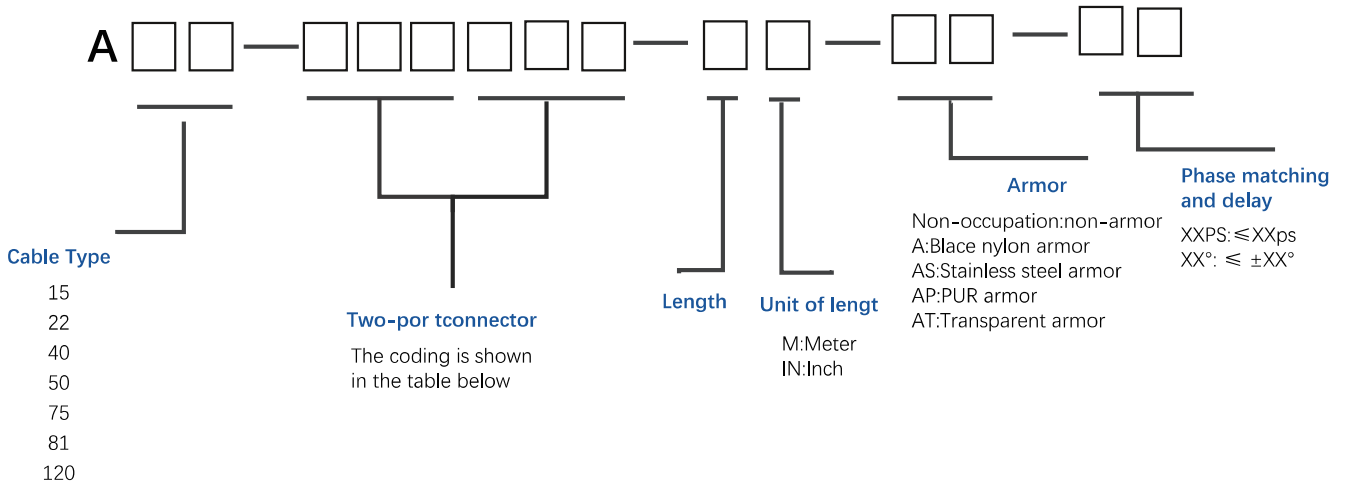

Optional Connectors

Connector Code	Connector Type	Operating Frequency	A15	A22	A40L	A40	A48	A50	A75	A81	A120	VSWR (Max)
1.0M	1.0mm Male	DC-110GHz	●									1.50
1.0F	1.0mm Female	DC-110GHz	●									1.50
1.85M	1.85mm Male	DC-67GHz	●	●								1.30
1.85F	1.85mm Female	DC-67GHz	●	●								1.30
2.4M	2.4mm Male	DC-50GHz		●		●						1.30
2.4F	2.4mm Female	DC-50GHz		●		●						1.30
2.92M	2.92mm Male	DC-40GHz		●	●	●						1.30
2.92WM	2.92 Male Right Angle	DC-40GHz		●	●	●						1.30
2.92F	2.92mm Female	DC-40GHz		●	●	●						1.30
3.5M	3.5mm Male	DC-27GHz					●	●				1.30
3.5F	3.5mm Female	DC-27GHz					●	●				1.30
SMPF	SMP Female	DC-40GHz		●								1.30
SSMAM	SSMA Male	DC-40GHz		●								1.30
SMAM	SMA Male	DC-27GHz		●		●	●	●	●	●		1.25
SMAWM	SMA Male Right Angle	DC-18GHz					●	●	●	●		1.25
SMAF	SMA Female	DC-27GHz		●		●	●	●	●	●		1.25
NM	N Male	DC-18GHz				●			●	●	●	1.25
NF	N Female	DC-18GHz				●			●	●	●	1.25
TNCM	TNC Male	DC-12GHz								●		1.25
SCM	SC Male	DC-6GHz								●		1.25
DINM	7/16 Male	DC-6GHz								●	●	1.25